

 MASTER SPAS® *presents*

MICHAEL PHELPS SIGNATURE SWIM SPAS



Michael Phelps

OWNER'S MANUAL

OWNER'S MANUAL

Welcome To Ultimate Relaxation!

Thank you for choosing your new swim spa built by Master Spas. Please read the entire Owner's Manual before installing and using your new swim spa. The goal of this manual is to provide you with safety and operational information plus some tips that will help you enjoy your swim spa to its fullest.

At the time of print, this manual is accurate in its information. Master Spas reserves the right to change or improve its product without prior notice. To check on updates or for other information, please visit www.masterspas.com and follow the links to the customer service section.

Record Of Ownership

Name _____

Address _____

City _____ State _____ Zip _____

Phone # (____) _____ - _____ Date Purchased ____/____/____

Model _____ Serial # _____

Dealer Name _____

Service Tech Rep _____

*Serial Number Location

The serial number for you swim spa is located on the listing plate on the front skirting panel, on the swim spa system control pack, and on the frame behind the right front removable corner. It will start with "H" followed by a 6-digit number. Ex. H140002



MASTER SPAS®

6927 Lincoln Parkway
Fort Wayne, Indiana 46804
800-860-7727
www.masterspas.com

TABLE OF CONTENTS

Important Safety Instructions	3-11	Propulsion System	50
Glossary of Swim Spa Terminology	12-15	Swim Control Operation	51
Electrical Installation Requirements	16-17	Fitness Workout	52-54
Wiring Schematic	18	Training Workout	55-57
Site Preparation / General Guidelines	19	Swim Workout	58-60
Installation Instructions	20	AquaVibe BT Audio System	61-65
Water Chemistry Terms	21-22	Swim Spa Trouble Shooting Guide	66-67
The Advantages of Eco Pur Filtration	23	Maintenance Recommendations	68-71
Water Quality Maintenance Start-Up	24	Swim Spa Propulsion System	
Water Quality Maintenance Schedule	25-26	Technical Information	72
Swim Spa Water Maintenance		WiFi Connection	73
Trouble-Shooting Guide	27	Swim Spa Care and	
Why Chemicals are Important	28	Maintenance Records	74-76
Maintenance Recommendations	29-30		
Winterizing Your Swim Spa	31		
Swim Spa Specifications	32		
Momentum 80, Signature, Force, and Impact			
Main Menu Screen	33-34		
Spa Screen	35		
Settings Screen	36-37		
Fill it Up!	38		
Swim Spa Behavior	39		
Time of Day	40		
Adjusting Filtration	41		
Restricting Operation	42		
Unlocking	42		
Additional Settings	43-44		
Information	45		
General Messages	46		
Heater Related Messages	47		
Sensor Related Messages	48		
Miscellaneous Messages	48		
System Related Messages	49		

SAFETY INSTRUCTIONS

SAVE THESE INSTRUCTIONS

Included with your new swim spa is a safety sign. The sign is for you and your guest's protection and is suitable for outdoor use in wet locations. The sign should be placed in a location visible to all users of the swim spa.

Please take time to point out the physical location of the safety sign and the importance of the safety precautions displayed on the safety sign to all of your guests. Remember, your safety and the safety of anyone who enjoys the use of your swim spa is our utmost concern.

The sign should be mounted with screws or another type of permanent fastener. Additional or replacement signs can be obtained from your dealer or direct from the factory.

INTRODUCTION

It's time to relax! You now have your very own portable swim spa by Master Spas, Inc. By fully understanding the operation of each of the features of your new swim spa, you will be assured of many years of hassle-free, hot water therapy and fun.

Your safety is of paramount importance to the Master Spas family. We urge you to read and become thoroughly familiar with all safety aspects addressed in this manual.

Through reading and totally understanding the important information in your owner's manual, you will realize that you now own **THE ULTIMATE RELAXATION MACHINE!**

NO DIVING

**DANGER: DIVING MAY
RESULT IN SERIOUS
INJURY OR DEATH.**



IMPORTANT SAFETY INSTRUCTIONS

When installing and using this electrical equipment, basic safety precautions should be observed including the following:

READ AND FOLLOW ALL INSTRUCTIONS

WARNING – To reduce the risk of injury, do not permit children to use this product unless they are closely supervised at all times.

A wire conductor is provided on this unit to connect a minimum 6 AWG (13.302mm²) solid copper conductor between this unit and any metal equipment, metal enclosures of electrical equipment, metal water pipe, or conduit within 5 feet (1.5m) of the unit

(For cord-connected/convertible units)

DANGER – Risk of injury.

- a) Replace damaged cord immediately.
- b) Do not bury cord.
- c) Connect to a grounded, grounding type receptacle only.

(For units intended for indoor use only)

WARNING – For indoor use only. This unit is not intended for outdoor use.

(For units intended for outdoor use only)

WARNING – For outdoor use only. This unit is not intended for indoor use.

NO DIVING

**DANGER: DIVING MAY
RESULT IN SERIOUS
INJURY OR DEATH.**



IMPORTANT SAFETY INSTRUCTIONS (CONT.)

(For units with GFCI)

WARNING – This product is provided with a ground-fault circuit interrupter located on the front panel of selected swim spas and on the power cord of 120 volt convertible swim spas. The GFCI must be tested before each use. With the product operating, open the service door. When the product stops operating, this merely indicates that the door is equipped with an electrical interlock. Next, push the test button on the GFCI and close the service door. The product should not operate. Now open the service door, push the reset button on the GFCI and close the service door. The product should now operate normally. When the product fails to operate in this manner, there is a ground current flowing indicating the possibility of an electric shock. Disconnect the power until the fault has been identified and corrected.

DANGER – Risk of Accidental Drowning. Extreme caution must be exercised to prevent unauthorized access by children. To avoid accidents, ensure that children cannot use this swim spa unless they are supervised at all times.

DANGER – Risk of Injury. The suction fittings in this swim spa are sized to match the specific water flow created by the pump. Should the need arise to replace the suction fittings or the pump, be sure that the flow rates are compatible.

Never operate swim spa if the suction fittings are broken or missing. Never replace a suction fitting with one rated less than the flow rate marked on the original suction fitting.

DANGER – Risk of Electric Shock. Install at least 5 feet (1.5m) from all metal surfaces. As an alternative, a swim spa may be installed within 5 feet of metal surfaces if each metal surface is permanently connected by a minimum 8AWG (8.4mm²) solid copper conductor to the wire connector on the terminal box that is provided for this purpose.

DANGER – Risk of Electric Shock. Do not permit any electric appliance, such as a light, telephone, radio, or television, within 5 feet (1.5 m) of a swim spa.

WARNING – To reduce the risk of injury:

- a) The water in a swim spa should never exceed 40°C (104°F). Water temperatures between 38°C (100°F) and 40°C are considered safe for a healthy adult. Lower water temperatures are recommended for young children and when swim spa use exceeds 10 minutes.

NO DIVING

**DANGER: DIVING MAY
RESULT IN SERIOUS
INJURY OR DEATH.**



IMPORTANT SAFETY INSTRUCTIONS (CONT.)

- b) Since excessive water temperatures have a high potential for causing fetal damage during the early months of pregnancy, pregnant or possibly pregnant women should limit swim spa water temperatures to 38°C (100°F).
- c) Before entering a swim spa, the user should measure the water temperature since the tolerance of water temperature- regulating devices varies.
- d) The use of alcohol, drugs, or medication before or during swim spa use may lead to unconsciousness with the possibility of drowning.
- e) Obese persons and persons with a history of heart disease, low or high blood pressure, circulatory system problems, or diabetes should consult a physician before using a swim spa.
- f) Persons using medication should consult a physician before using a swim spa since some medication may induce drowsiness while other medication may affect heart rate, blood pressure, and circulation.

(For swim spas with a gas heater)

WARNING – Risk of Suffocation. This swim spa is equipped with a gas heater and is intended for outdoor use only unless proper ventilation can be provided for an indoor installation.

HYPERTHERMIA

Hyperthermia occurs when the internal temperature of the body reaches a level several degrees above the normal body temperature of 98.6° F.

THE SYMPTOMS OF HYPERTHERMIA INCLUDE:

- Dizziness • Fainting • Drowsiness • Lethargy
- Increase in Internal Body Temperature

THE EFFECTS OF HYPERTHERMIA INCLUDE:

Unawareness of Impending Hazard • Failure to Perceive Heat • Failure to Recognize the Need to Exit Swim Spa • Physical Inability to Exit Swim Spa • Fetal Damage in Pregnant Women • Unconsciousness Resulting in a Danger of Drowning

SAFETY INSTRUCTIONS

NO DIVING

**DANGER: DIVING MAY
RESULT IN SERIOUS
INJURY OR DEATH.**



IMPORTANT SAFETY INSTRUCTIONS (CONT.)

DANGER – To reduce the risk of injury to persons, do not remove the suction grate. Suction through drains and skimmers is powerful when the jets in the swim spa are in use. Damaged covers can be hazardous to small children and adults with long hair. Should any part of the body be drawn into these fittings, turn off the swim spa immediately. As a precaution, long hair should not be allowed to float in the swim spa.

WARNING – Install the swim spa so that water can be easily drained out of the compartment containing electrical components so as not to damage equipment. When installing the swim spa make sure to allow for an adequate drainage system to deal with any overflow water. Please allow for at least 2 feet of clearance around the perimeter of the swim spa to provide enough room to access for servicing. Contact your local dealer for their specific requirements.

WARNING – The swim spa should be covered with an approved locking cover when not in use, to prevent unauthorized entry and injuries.

WARNING – People with infections, sores or the like should not use the swim spa. Warm and hot water temperatures may allow the growth of infectious bacteria if not properly disinfected.

CAUTION – Safe temperatures for swimming or aquatic exercise is around 80°F.

CAUTION – Risk of Electrical Shock. Do not leave audio compartment open. Audio controls are not to be operated while inside the swim spa.

CAUTION – Replace components only with identical components.

WARNING – Risk of Electric Shock. Do not connect any auxiliary components (for example, additional speakers, headphones, additional audio/ video components etc.) to the system. These units are not provided with an outdoor antenna.

Do not service this product yourself as opening or removing covers may expose you to dangerous voltage or other hazards. Refer all servicing to qualified service personnel.

If the power supply cord(s) are damaged, water is entering the speaker, audio compartment, or any other component in the electrical equipment compartment area, the protective shield is showing signs of deterioration, or there are signs of other potentially hazardous damage to the unit, turn off the circuit breaker from the wall and refer servicing to qualified personnel.

NO DIVING

**DANGER: DIVING MAY
RESULT IN SERIOUS
INJURY OR DEATH.**



IMPORTANT SAFETY INSTRUCTIONS (CONT.)

The unit should be subjected to periodic routine maintenance once every quarter to make sure that the it is operating properly.

DANGER – Risk of Electric Shock. A green colored terminal or a terminal marked G, GR, Ground, Grounding or the symbol shown in Figure 14.1 of UL 1563 is located inside the supply terminal box or compartment. To reduce the risk of electric shock, this terminal must be connected to the grounding means provided in the electric supply service panel with a continuous copper wire equivalent in size to the circuit conductors supplying this equipment.

At least two lugs marked “Bonding Lugs” are provided on the external surface or on the inside of the supply terminal box or compartment. To reduce the risk of electric shock, connect the local common bonding grid in the area of the swim spa to these terminals with an insulated or bare copper conductor not smaller than 8AWG.

All field installed metal components such as rails, ladders, drains, or other similar hardware within 3m of the swim spa shall be bonded to the equipment grounding bus with copper conductors not smaller than 8AWG.

SAVE THESE INSTRUCTIONS

SWIM SPA PROPULSION SYSTEM - TECHNICAL INFORMATION

Critical replacement component part numbers:

WARNING: Items listed below shall only be replaced with identical components unless approved by Master Spas Engineering Department. Any change or alteration to the system components will cause a safety hazard and void the safety certification.

- Propulsion suction grate assembly: X804490

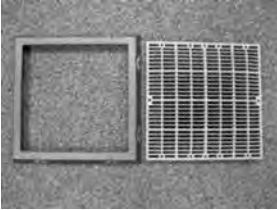

- Propulsion grate fasteners (4 per grate): X717900



- Propeller
 - Wave.....X400125
 - Wave XPX400820
 - Wave XP PROX400820
- Max. Frequency
 - Wave..... 66Hz.
 - Wave XP 60Hz.
 - Wave XP PRO 68Hz.

PROPULSION SUCTION GRATES MISC. SPECIFICATIONS:

- Wall mount only
- Life span 7 years
- Tools required – No. 2 Phillips screwdriver
- Pulley system shall be 1:1 ratio only

Note: Fittings and fasteners should be observed for damage or tampering before each use of the swim spa.

SAFETY INSTRUCTIONS

WARNING: CHILDREN SHOULD NOT USE SWIM SPAS OR HOT TUBS WITHOUT ADULT SUPERVISION

AVERTISSEMENT: NE PAS LAISSER LES ENFANTS UTILISER UNE CUVE DE RELAXATION SANS SURVEILLANCE

WARNING: DO NOT USE SWIM SPAS OR HOT TUBS UNLESS ALL SUCTION GUARDS ARE INSTALLED TO PREVENT BODY AND HAIR ENTRAPMENT.

AVERTISSEMENT: POUR ÉVITER QUE LES CHEVEUX OU UNE PARTIE DU CORPS PUISSENT ÊTRE ASPIRES, NE PAS UTILISER UNE CUVE DE RELAXATION SI LES GRILLES DI PRISE D'ASPIRATION NE SONT PAS TOUTES EN PLACE

WARNING: PEOPLE USING MEDICATIONS AND/OR HAVING AN ADVERSE MEDICAL HISTORY SHOULD CONSULT A PHYSICIAN BEFORE USING A SWIM SPA OR HOT TUB.

AVERTISSEMENT: LES PERSONNES QUI PRENNENT DES MÉDICAMENTS OU ONT DES PROBLÈMES DE SANTÉ DEVRAIENT CONSULTER UN MÉDECIN AVANT D'UTILISER UNE CUVE DE RELAXATION

WARNING: PEOPLE WITH INFECTIOUS DISEASES SHOULD NOT USE A SWIM SPA OR HOT TUB

AVERTISSEMENT: LES PERSONNES ATTEINTES DE MALADIES INFECTIEUSES NE DEVRAIENT PAS UTILISER UNE CUVE DE RELAXATION

WARNING: TO AVOID INJURY EXERCISE CARE WHEN ENTERING OR EXITING THE SWIM SPA OR HOT TUB.

AVERTISSEMENT: POUR ÉVITER DES BLESSURES, USER DE PRUDENCE EN ENTRANT DANS UNE CUVE DE RELAXATION ET EN SORTANT

WARNING: DO NOT USE DRUGS OR ALCOHOL BEFORE OR DURING THE USE OF A SWIM SPA OR HOT TUB TO AVOID UNCONSCIOUSNESS AND POSSIBLE DROWNING

AVERTISSEMENT: POUR ÉVITER L'ÉVANOUISSEMENT ET LA NOYADE ÉVENTUELLE, NE PRENDE NI DROGUE NI ALCOOL AVANT D'UTILISER UNE CUVE DE RELAXATION NI QUAND ON S'Y TROUVE

WARNING: PREGNANT OR POSSIBLY PREGNANT WOMEN SHOULD CONSULT A PHYSICIAN BEFORE USING A SWIM SPA OR HOT TUB.

AVERTISSEMENT: LES FEMMES ENCEINTES, QUE LEUR GROSSESSE SOIT CONFIRMÉE OU NON, DEVRAIENT CONSULTER UN MÉDECIN AVANT D'UTILISER UNE CUVE DE RELAXATION

WARNING: WATER TEMPERATURE IN EXCESS OF 38°C MAY BE INJURIOUS TO YOUR HEALTH

AVERTISSEMENT: IL PEUT ÊTRE DANGEREUX POUR LA SANTÉ DE SE PLONGER DANS DE L'EAU A PLUS DE 38°C

WARNING: BEFORE ENTERING THE SWIM SPA OR HOT TUB MEASURE THE WATER TEMPERATURE WITH AN ACCURATE THERMOMETER

AVERTISSEMENT: AVANT D'UTILISER UNE CUVE DE RELAXATION MESURER LA TEMPÉRATURE DE L'EAU À L'AIDE D'UN THERMOMÈTRE PRÉCIS

SAFETY INSTRUCTIONS

WARNING: DO NOT USE A SWIM SPA OR HOT TUB IMMEDIATELY FOLLOWING STRENUOUS EXERCISE

AVERTISSEMENT: NE PAS UTILISER UNE CUVE DE RELAXATION IMMÉDIATEMENT APRÈS UN EXERCISE FATIGANT

WARNING: PROLONGED IMMERSION IN A SWIM SPA OR HOT TUB MAY BE INJUROUS TO YOUR HEALTH

AVERTISSEMENT: L'UTILISATION PROLONGÉE D'UNE CUVE DE RELAXATION PEUT ÊTRE DANGEREUSE POUR LA SANTÉ

WARNING: DO NOT PERMIT ELECTRIC APPLIANCES (SUCH AS LIGHT, TELEPHONE, RADIO, OR TELEVISION) WITHIN 1.5 M OF THIS SWIM SPA OR HOT TUB

AVERTISSEMENT: NE PAS PLACER D'APPAREIL ÉLECTRIQUE (LUMINAIRE, TÉLÉPHONE, RADIO, TÉLÉVISEUR, ETC) À MOINS DE 1.5 M DE CETTE CUVE DE RELAXATION

CAUTION: MAINTAIN WATER CHEMISTRY IN ACCORDANCE WITH MANUFACTURER'S INSTRUCTION

ATTENTION: LA TENEUR DE L'EAU EN MATIÈRES DISSOUTES DOIT ÊTRE CONFORME AUX DIRECTIVES DU FABRICANT

Hyperthermia occurs when the internal temperature of the body reaches a level several degrees above the normal body temperature of 37°C. The symptoms of hyperthermia include drowsiness, lethargy, and an increase in the internal temperature of the body. The effects of hyperthermia include

- (a) unawareness of impending hazard;
- (b) failure to perceive heat;
- (c) failure to recognize the need to exit swim spa;
- (d) physical inability to exit swim spa;
- (e) fetal damage in pregnant women; and
- (f) unconsciousness and danger of drowning.

WARNING: THE USE OF ALCOHOL OR DRUGS CAN GREATLY INCREASE THE RISK OF FATAL HYPERTHERMIA IN HOT TUBS AND SWIM SPAS

LA CONSOMMATION D'ALCOOL OU DE DROGUE AUGMENTE CONSIDÉRABLEMENT LES RISQUES D'HYPERTHERMIE MORTELLE DANS UNE CUVE DE RELAXATION.

GLOSSARY OF SWIM SPA TERMINOLOGY

1. THERAPY JETS

Your new swim spa features a variety of jet styles. All jets, regardless of style return the water to the swim spa. Air is mixed with the water by using the air controls creating a gentle to most vigorous massage. Water flow is adjusted by simply turning the outer face of the jet.



Extreme Seat

2. JET DIVERTER VALVE

Located on the topside of the swim spa, this valve physically diverts the flow of water from one jet zone of the swim spa to another jet zone.

Be sure that no sand or particles are brought into the swim spa as they can cause the diverter to seize up. It is best to turn the diverter valve only when the pump is turned off.



Jet Diverter

3. CASCADE WATERFALL / LAMINAR FLOW VALVE

Located on the topside of the swim spa, this valve adjusts water flow to the cascade waterfall and the Laminar Flow Jets. This feature is available on the Legend Series only. NOTE: See "Maintenance Recommendations" for instructions on cleaning your Laminar Flow Jets.

4. AIR CONTROL VALVES

These are located around the top of your swim spa. You may increase or decrease the force of your jets by opening or closing the air control valves. Typically, one dial controls the air to water ratio and mix to one group of jets. When not in use the air controls should be kept in the closed position, as air bubbles tend to cool the water.



Air Control Valve

GLOSSARY OF SWIM SPA TERMINOLOGY

5. TOPSIDE CONTROL PANEL

You may safely control all functions from inside or outside your swim spa using the Topside Control Panel. This Panel is used to control the water temperature, pumps, the swim spa light, automatic filtration cycles and other advanced functions. The digital display will give you a constant temperature readout and will notify you in case of certain malfunctions. Several user programmable functions are also available.

6. PROPULSION SYSTEM CONTROL PANEL

You may safely control the speed of the propulsion system from the inside of your swim spa by using the buttons on the control panel mounted in the swim area. This control panel is used to turn the propulsion system on and off and to adjust the intensity of the water flow.

Your swim spa may have one of three propulsion systems depending on the equipment option: Wave, Wave XP, or Wave XP Pro. All three systems operate in the same manner using the control panel mounted on the swim end of your swim spa. This control panel may be safely used from inside or outside of the swim spa to operate the propulsion system.

7. PERSONAL REMOTE CONTROL

Your swim spa has an additional remote which allows the user to control the stand up jet therapy cove. By pressing the control one time, you will activate the pump. Press the pad again to turn the pump off.



Personal Remote Control

8. EQUIPMENT ACCESS PANEL

Located behind the side panel below the Topside Control Panel, this area houses the major components responsible for the swim spas operation. Those components include the pumps, heater, control panel box, Ozonator, and LED light system. Pump and equipment placement may vary by model.

9. PROPULSION SYSTEM CONTROLS ACCESS

The propulsion control system is located behind the skirt panel designated as "E" in the drawing on page 14. The propulsion motor, propulsion control pack, and pulleys for the system are located in this area.

GLOSSARY OF SWIM SPA TERMINOLOGY

10. ACCESS PANELS

These are located on all four sides of the swim spa. All of the panels are removable should service be required.

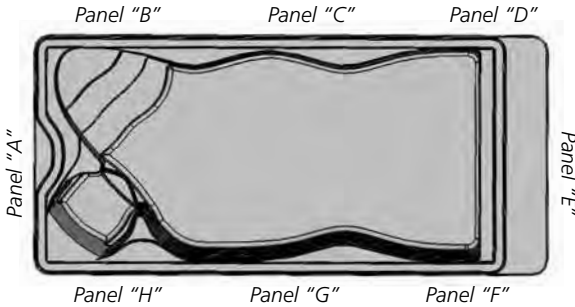

NOTE: Note: The above drawing illustrates the panel placement on the swim spa.

WARNING: Do Not Remove Access Panels Without Turning Off Power To The Swim Spa.

11. DRAINING YOUR SWIM SPA

Due to the physical size of the swim spa, we recommend draining your swim spa with a submersible sump pump. Draining your swim spa with a conventional swim spa drain is not a reasonable option. When draining the Momentum 80 swim spa always drain the water from the swim spa side before draining the swim side. When filling the swim spa always fill the swim side before filling the spa side.

12. WEIR GATE

The weir gate is the horizontal door located in front of the filters that trap debris in the filter area.

13. SWIM SPA LIGHT

Your swim spa lighting is designed for safety and is located on the interior walls of your swim spa.

The on/off switch is located on the topside control panel.

14. EQUIPMENT CONTROL SYSTEM

This houses the wiring and electrical components necessary to operate the swim spa.

15. SWIM SPA HEATER

This element is an electric heater housed in a stainless steel tube. It is thermostatically controlled and equipped with a high-limit temperature safety shut-off sensor. The high-limit sensor cannot be reset until the temperature within the heater assembly drops several degrees below the shut-off temperature of 108° - 110° F. Should the high-limit switch trip repeatedly, contact your dealer or qualified service representative to diagnose the problem. Your swim spa will heat approximately 1° - 2° per hour, on average when the cover is closed. These times may vary and the swim spa should have a cover installed.

GLOSSARY OF SWIM SPA TERMINOLOGY

16. SLICE VALVES

These valves are used by service personnel to shut off water to the heater, main pump system and secondary pump system so that the water does not need to be drained should the swim spa require service.

***NOTE:** Slice valves must be completely open during normal operation.



Slice Valve and Pump Union

17. MAIN PUMP

The main pump produces water flow through the jets and has a high and low speed. Low speed will produce efficient water circulation during filtration and gentle jet action. High speed should be used for maximum jet action. The water flow may be directed to different areas of the swim spa depending on the position of the diverter controls.

18. SECONDARY PUMP

This pump produces water flow through the stand up jet system. The second pump can be controlled by the main topside panel and also the personal remote mounted on the surface of the swim spa.

19. PUMP UNION

These are used by service personnel to easily service the pumps.

20. HEATER UNION

These are used by service personnel to easily service the heater.

21. OZONATOR

Your ozonator will operate in conjunction with the filter system. Ozone is a powerful gas that oxidizes contaminants in the water.

ELECTRICAL INSTALLATION REQUIREMENTS

ELECTRICAL INSTALLATION REQUIREMENTS

!! FORCE, IMPACT, AND SIGNATURE WAVE XP !!

HAVE YOUR ELECTRICIAN READ THE FOLLOWING INFORMATION BEFORE INSTALLATION BEGINS

Electrical connections made improperly, or the use of wire gauge sizes for incurring power which are too small, may continually blow fuses in the electrical equipment box, may damage the internal electrical controls and components, may be unsafe and in any case will void your warranty.

It is the responsibility of the swim spa owner to ensure that electrical connections are made by a qualified electrician in accordance with the National Electrical Code and any local and state electrical codes in force at the time of installation.

These connections must be made in accordance with the wiring diagrams found inside the control box. This equipment has been designed to operate on 60Hz. alternating current only, 240 volts are required. Make sure that power is not applied while performing any electrical installation. A copper bonding lug has been provided on the electrical equipment pack to allow connection to local ground points. The ground wire must be at least 8 AWG copper wire and must be connected securely to a grounded metal structure such as a cold water pipe. All Master Spas equipment packs are wired for 240 VAC only. The only electrical supply for your swim spa must include a 50 AMP switch or circuit breaker to open all non-grounded supply conductors to comply with section 422-20 of the National Electrical Code. A disconnect must be installed and be readily accessible to the swim spa occupants, but installed at least five feet from the swim spa. A Ground-Fault circuit interrupter (GFCI) must be used to comply with section 680-42 of the National Electric Code. The Force, Impact and Signature Wave XP swim spas come equipped from the factory with a GFCI breaker and will not need to have one installed. A ground fault is a current leak from any one of the supply conductors to ground. A GFCI is designed to automatically shut off power to a piece of equipment when a ground fault is detected.

Power hook-up to the swim spa must be 240 volt 3 wire plus ground (6 AWG copper) 8 AWG copper ground.

Route the cable into the equipment area for final hook-up to terminals inside the control panel. The swim spa must be hooked up to a “dedicated” 240 volt, 50 amp breaker and GFCI. The Force, Impact and Signature Wave XP come equipped from the factory with this GFCI breaker. The term “dedicated” means the electrical circuit for the swim spa is not being used for any other electrical items (patio lights, appliances, garage circuits, etc.). If the swim spa is connected to a non-dedicated circuit, overloading will result in “nuisance tripping” which requires resetting of the breaker switch at the house electrical panel. Rev. 11/11

Permanently Connected Equipment Assembly with Pump(s), Heaters, Luminaine, Ozone, Swim Spa Side Control(s), Pump shut off device, and Audio/Video Components.

Note: Some of the above components may be optional or not available with every swim spa model.

ELECTRICAL INSTALLATION REQUIREMENTS

ELECTRICAL INSTALLATION REQUIREMENTS

!! FOR MOMENTUM 80 AND SIGNATURE WAVE XP PRO !!
HAVE YOUR ELECTRICIAN READ THE FOLLOWING INFORMATION
BEFORE INSTALLATION BEGINS

The Momentum 80 swim spa requires two separate electrical power supplies.

A 50 amp dedicated electrical service using #6 AWG copper wire should be ran to the junction box in the swim spa. This line should NOT have an external GFCI installed since the swim spa has an internal GFCI installed. (See electrical hook-up requirements on page 16).

A 30 amp dedicated electrical service using #8 AWG copper wire should be ran to the Swim Spa control pack. This is the control pack that is NOT hooked to the main junction box in the swim spa. This electrical supply must be protected by an external GFCI (see wiring diagram on page 16).

The Signature Wave XP Pro swim spa requires two separate electrical power supplies.

A 50 amp dedicated electrical service using #6 AWG copper wire should be ran to the junction box in the swim spa. This line should NOT have an external GFCI installed since the swim spa has an internal GFCI installed. (See electrical hook-up requirements on page 16).

A 50 amp dedicated electrical service using #6 AWG copper wire should be ran to the Swim Spa control pack. This is the control pack that is NOT hooked to the main junction box in the swim spa. This electrical supply must be protected by an external GFCI (see wiring diagram on page 18).

WIRING SCHEMATIC - WIRING FOR MODELS THAT REQUIRE A SEPARATE GFCI BREAKER

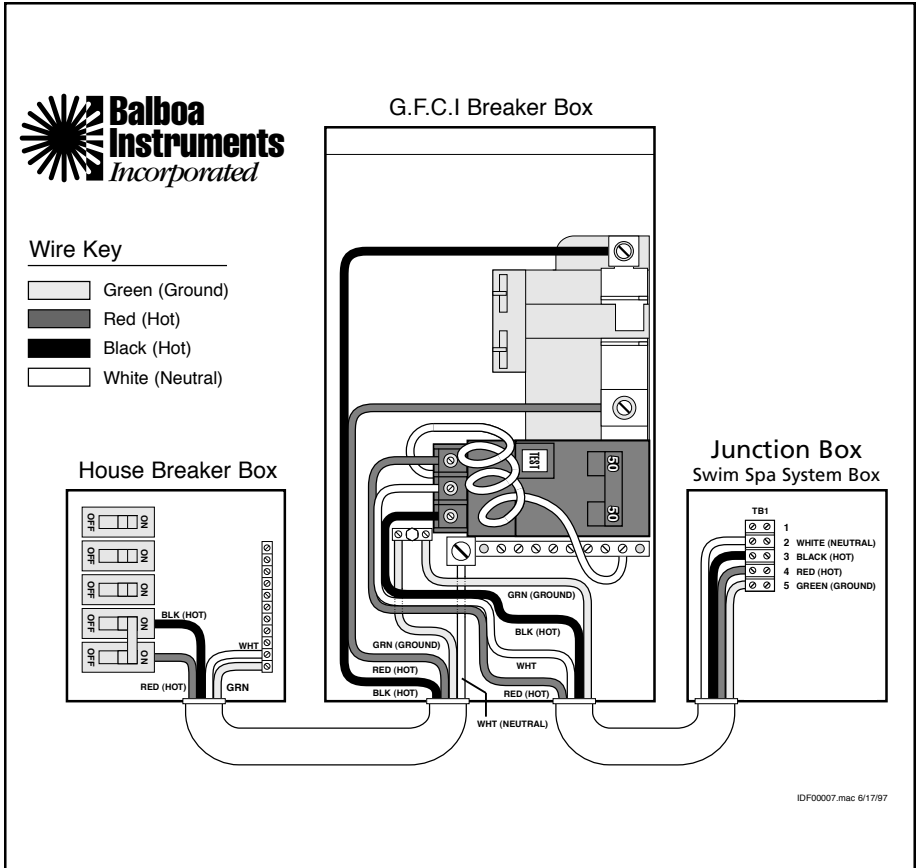

* Actual wiring of GFCI will vary by manufacturer of GFCI. The GFCI shown is a Square D. Improper wiring of GFCI may result in permanent damage to swim spa system box. Repair / replacement of swim spa system box is not covered under warranty when damage results from improper wiring. Actual wire attachment points on the junction box may vary with different models. Always refer to the wiring diagram inside the junction box for proper connection.

SITE PREPARATION / GENERAL GUIDELINES

Swim spa installation is simple when properly planned. It is important that you read the following information carefully and consult with your Master Spas dealer.

- 1. Access** - The actual dimensions of your new swim spa will determine the amount of space that is needed in moving the swim spa from curbside to its final installation area. Be sure to measure side yard dimensions, gates or doors and vertical obstructions such as roof overhangs and overhead cables. Any other space limiting obstacles such as trees or shrubs must be evaluated.
- 2. Surface/Pad Requirements** - When your new swim spa is filled with water and bathers, it may weigh as much as several tons. It is imperative that the base beneath the swim spa can support the entire weight. The swim spa must be on a uniformly firm, continuous, and level surface. The recommended foundation is a concrete pad with a minimum thickness of four (4) inches with steel reinforcement bars crossed throughout the pad.

IMPORTANT

Be sure to locate your swim spa so that the equipment remains above grade and is not subject to flooding.

The equipment side(s) of the swim spa must be accessible in the event that future service is needed. In the event that service is required, your dealer will need at least 2 feet of clearance around the perimeter of the swim spa. Periodical maintenance checks require entry into the equipment bay. When possible, it is wise planning for the future to leave access, to all sides of the swim spa in the event your swim spas plumbing requires maintenance. Your swim spa warranty does not cover the cost of providing access for service.

GENERAL CONSIDERATIONS FOR OUTDOOR INSTALLATION

Again, proper planning will increase your total enjoyment factor with your new swim spa. Listed below are some additional items to consider when planning your installation.

- How swim spa will complement landscaping and vice versa
- View from inside swim spa and view of swim spa from inside of home
- Exposure to sunlight and shading from trees
- Privacy
- Getting to swim spa from house and return
- Proximity to dressing rooms and bathrooms
- Storage for swim spa chemicals
- Local building codes (if applicable)
- Power cable

NOTE: The Swim Spa is to be used in private, residential use only. Operating an Swim Spa for commercial use will void the warranty.

INSTALLATION INSTRUCTIONS

1. Put swim spa in final position that allows for access to equipment and swim spa components.
2. Remove skirt panels to access the electrical connections. For the Momentum 80 and Signature Wave XP Pro remove panels A, B, and C. For the Force and Impact, remove panel B.

3.  Be sure all pump and heater unions are secure. Each pump has 2 unions and the heater has 2 unions. A newly delivered swim spa may have loose unions caused in transporting the swim spa. Check that all slice valves are open, in the up position. The slice valves may become closed during transportation of the swim spa.

Slice Valve and Pump Union

4. Fill the swim spa to the “minimum safe water level” sticker. On the Momentum 80 it is recommended that the swim side be filled first and then the end with the therapy seats. When draining the swim spa always drain the spa side before draining the swim side.

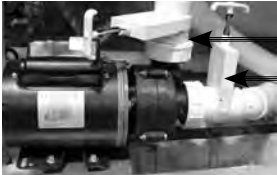
5.  Turn on power to the swim spa. If your swim spa is equipped with two electrical supplies, make sure that they are both turned on. The swim spa will go through its priming mode. This lasts approximately 5 minutes. The purpose of the priming mode is to help insure that the jet pumps have been primed with water and are ready to operate. It may be necessary in some instances to bleed air from the jet pumps in your swim spa, if after the priming mode the swim spa pumps run but do not move water the pump may have an air lock.

some instances to bleed air from the jet pumps in your swim spa, if after the priming mode the swim spa pumps run but do not move water the pump may have an air lock.

Due to the nature of water flow and hydro-therapy pumps, please be advised that air locking of pumps may occur. Master Spas, Inc. has taken measures to reduce the possibility of this, but it still may occur, especially after filling the swim spa. This is not a service covered by the warranty and service charges may apply.

To relieve an airlock situation, loosen the pump union on the discharge of the pump. This pump union is indicated by an arrow in the picture below. Water should leak out of the union once the air has been removed. Tighten the union and test the pump for proper operation. Repeat this process if needed.

- *NOTE:** Upon power up, the propulsion system may mix water with air for up to several minutes until all of the air is pulled from the propulsion chamber. The propulsion system may be noisy during this time. This is normal.

6. Be sure the jets in your swim spa are open. See 68 page for removal instructions.

7.  The Momentum 80 has an additional air bleed system that helps aid in relieving air locks. There is an air bleed valve located in the filter area of the swim spa portion of the swim spa. When filling the swim spa this should be opened to facilitate relieving any air that may be trapped in the pumps. Make sure that the plug is reinstalled once the swim spa is running correctly.

Air Bleed Valve

8. Adjust water chemistry according to the instructions provided in the Swim Spa “Water Quality Maintenance” Section. (page 24).
9. Your swim spa water will heat approximately 1° - 2° per hour, on average. Times may vary.

WATER CHEMISTRY TERMS YOU SHOULD KNOW

Before jumping into the Swim Spa Water Maintenance, here are some terms to help you.

1. **Parts per million, or ppm:** This is a form of measurement used in most pool or swim spa chemical readings. Best described as any one million like items of equal size and make up, next to one unlike item, but of equal size. This would be one part per million.
2. **Total Alkalinity:** This is a measurement of the ability of the water to resist changes in pH. Put another way, it is the water's ability to maintain proper pH. Total alkalinity is measured in parts per million from 0 to 400 plus, with 80 to 120 ppm being the best range for swim spas. With low alkalinity, the pH will flip, or change back and forth, and be hard to control. With high alkalinity it becomes extremely difficult to change the pH.
3. **pH or potential hydrogen:** This is a measurement of the active acidity in the water, or it is the measurement of the concentration of active hydrogen ions in the water. The greater the concentration of active hydrogen ions, the lower the pH. pH is not measured in parts per million, but on a scale from 0 to 14, with 7 being the neutral. In swim spas when ever possible, a measurement between 7.2 and 7.8 is best. Whenever possible, it should be between 7.4 and 7.6. With low pH, the results can be corroded metals, etched and stained plaster, stained fiberglass or acrylic, eye / skin irritation, rapid chlorine or bromine loss, and total alkalinity destruction. With high pH, the results can be cloudy water, eye / skin irritation, scale formation and poor chlorine or bromine efficiency.
4. **Shocking:** This is when you add either extra chlorine (superchlorinate) by raising the chlorine level above 8 ppm, or add a non-chlorine shock (potassium monoperoxysulfate or potassium monopersulfate) to burn off the chloramines or bromamines. A non-chlorine shock acts by releasing oxygen in the water, which serves the same function as chlorine. The advantage to using non-chlorine shock, is you can enter the water within 15 minutes after shocking. Using chlorine, you must wait until the total chlorine reading is below 5 ppm. One thing to remember, a non-chlorine shock will not kill bacteria or disinfect.
5. **Sequestering:** This can be defined as the ability to form a chemical complex which remains in solution, despite the presence of a precipitating agent (i.e. calcium and metals). Common names for sequestering chemicals are; minquest, stain and scale control, metal-x, swim spa defender, swim spa metal gone, (etc.).
6. **Filtration:** Filters are necessary to remove particles of dust, dirt, algae, etc. that are continuously entering the water. If the swim spa is not operated long enough each day for the filter to do a proper job, this puts a burden on the chemicals, causing extra expense. A spare cartridge should be kept on hand to make it easy to frequently clean the cartridge without the need for a long shut down. This will also allow the cartridge to dry out between usages, which will increase the cartridge life span as much as twice. Replace the cartridge when the pleats begin to deteriorate. Cartridge cleaning should be done a minimum of once a month. More often with a heavy bather load.
7. **Sanitizers:** This is what kills the germs and bacteria that enter the water from the environment and the human body.
 - A. Chlorine
 1. Only one type of chlorine is approved for swim spa use: Sodium dichlor which is granular, fast dissolving, and PH neutral chlorine.
 2. Chlorine is an immediate sanitizer.
 - B. Bromine (Note: Bromine use is not recommended with Eco Pur filters.)
 1. Two types of tablets.
 - a. Hydrotech
 - b. Lonza
 2. Bromine is a slow dissolve chemical and may take a few days to develop a reserve or reading in the water.

WATER CHEMISTRY TERMS YOU SHOULD KNOW

8. **Total dissolved solids (TDS):** Materials that have been dissolved by the water. i.e. Like what happens when you put sugar in coffee or tea.
 9. **Useful life of water (in days):** Water should be drained at least once every 180 days. Useful life may vary by usage and bather load.
 10. **Defoamer:** Foaming may be caused by body oils, cosmetics, lotions, surface cleaners, high pH or algeacides as well as other organic materials. Low levels of calcium or sanitizer can also cause foaming. Also, double rinse your bathing suits as they will hold residual soap after being washed.
 11. **Calcium hardness:** Water that is too hard (over 250 ppm) can promote scale formation in components and on swim spa surface. Water that is too low (below 180 ppm) may also shorten the life of metal components on the swim spa.
- NOTE:** Always leave swim spa cover open for 15 min. after adding chemicals to prevent off gas from damaging your cover, pillows and other critical parts.

THE ADVANTAGES OF ECO PUR™ FILTRATION



Eco Pur™ water filter system is designed to reduce the use of chemicals in your swim spa. You will still be required, periodically, based on usage to add a small amount of chlorine to oxidize organic compounds in the water. The Eco Pur™ filter system will not eliminate the need to maintain proper water chemistry but can make the maintenance a more natural experience.

FEATURES

- The Eco Pur™ filter system will not oxidize organic compounds and will require periodic doses of chlorine to assist in the sanitization and oxidation processes required to maintain clear swim spa water.
- Eco Pur™ filter system will not alter the pH of swim spa water. The Eco Pur™ filter system will actually aid in stabilizing the pH. Eco Pur™ does not alter the (TDS) total dissolved solids.
- The main function of the Eco Pur™ filter system is to provide clean and clear swim spa water. Proper chemical balance and filtration are also key components in maintaining healthy swim spa water. Always ensure that the pH and total alkalinity of the swim spa water is checked and balanced at all times. To ensure proper filtration, clean the regular filter cartridge with a "filter cleaner" every 30 days and rinse the Eco Pur™ cartridge with a hose to remove any buildup of contaminants. (Do not soak the Eco Pur™ cartridge in filter cleaner.) If water appears to be visually cloudy, dull, or has an odor, shock the swim spa water with 1 ounce of chlorine* to remove excessive contaminants. When cleaning filters, be sure to never have the pumps (including the circulation pump) running without the filters in place. Failure to do so may result in debris being drawn into the pumps causing unwarranted damage.
- Helps remove calcium carbonate and hydrogen sulphide from swim spa water to protect heaters and equipment from precipitation.
- Helps stabilize the pH and alkalinity of the swim spa water.
- Helps reduce chemical usage and still provide safe odor-free water.
- Helps deplete excess chlorine after chemical shock to prevent damage to skin, hair, and swim wear.
- Helps to produce ultra clean and clear water.

Note: Eco Pur™ filters are not recommended for use with Bromine. Consult your dealer for additional information.

Master Spas, Inc. products are not designed to be used with Biquanides. These chemicals are found in SoftSwim® and Baqua Spa® products. Due to adverse effects from these types of sanitizers, the use of these products may void the swim spa warranty.

WATER QUALITY MAINTENANCE START-UP

For Eco Pur™ Water Filter System

- Step 1:** Your swim spa should be filled using a Pre-filter, which can be obtained from your local dealer. This Pre-filter will help remove many of the minerals existing in the water, which will make adjusting the water balance easier after a new fill. Never use more than 50% softened water when filling the swim spa.
- Step 2:** During the initial filling of the swim spa, add a sequestering agent to combat suspended minerals in the water. The agents are sold under many different names such as Mineral Clear, Stain and Scale, Metal Protect, and other brands. Allow water to circulate and filter for at least 12 hours before adding any other chemicals.
- Step 3:** Test water for pH, total Alkalinity, and Calcium hardness. The pH should be 7.2 - 7.8 and the total Alkalinity 80-150 PPM. Calcium hardness levels should be maintained between 150 and 250 PPM (part per million).
- Step 4:** Adjust pH and total Alkalinity (TA) utilizing the directions on the chemical bottles. Wait 15 minutes, test and adjust if necessary.
- Step 5:** It may be necessary to retest and add additional chemicals to get to the proper levels in Step 3.
- Step 6:** Add 2 ounces of concentrated chlorinating granules* (sodium Dichlor-s-triazinetreone) on initial start up to begin sanitizing the swim spa water. Always refer to the chemical manufactures dosage recommendations listed on the container. It is important not to add the chlorinating granules until the pH, alkalinity and calcium hardness have been adjusted to their proper levels.

*SPECIAL NOTE:

We recommend a minimum level of 1.0 ppm residual chlorine be maintained in swim spa water. Always refer to the chemical manufacturer's dosage recommendations listed on the container.

When adding chlorine or non-chlorine shock/oxidizer always broadcast across the water while the pumps are running.

The quantities of sanitizer and oxidizer shown in this manual are for 500 gallon swim spas and may have to be adjusted depending on the actual amount of water that your swim spa holds. See the specifications section of this manual for the correct gallons of your swim spa.

The concentration of active ingredients in swim spa chemicals varies by manufacturer. Swim spa chemicals are the same as spa chemicals. The amounts of sanitizer suggested in this manual are based on swim spa chemicals that have the active ingredient percentages listed below:

Chlorine	Non-Chlorine Shock/ Oxidizer
Active ingredient:	Active ingredient:
Sodium dichlor 99%	Potassium peroxymonosulfate 42.8%
Other ingredients..... 1%	Inert ingredients 57.2%
Total 100%	Total 100%

WATER QUALITY MAINTENANCE SCHEDULE - ECO PUR™

BEFORE EACH USE

Check swim spa water with a test strip for proper sanitation levels and adjust accordingly to the proper levels. Free chlorine level should be 1-3 ppm.

ONCE A WEEK

Add 1 ounce of non-chlorine shock/oxidizer* or chlorine* to swim spa to help maintain the water quality.

3 TIMES A WEEK

Test water using chemical test strips. Adjust sanitizer, pH and Alkalinity accordingly. The total alkalinity should be between 80 - 150 ppm and the PH should be between 7.2 - 7.8.

ONCE A MONTH

Soak your regular filter elements overnight in a container with swim spa Filter Cleaner and then rinse with clean water. For best results, allow the filter to dry before re-inserting. (The Eco Pur™ mineral element should never be cleaned in a filter cleaner. Just rinse with water.) When cleaning filters, be sure to never have the pumps (including the circulation pump) running without the filters in place. Failure to do so may result in debris being drawn into the pumps causing unwarranted damage. See the “clean your filter elements” in the maintenance section of this manual for more information.

EVERY 180 DAYS

Drain and refill your swim spa with fresh water, install a new Eco Pur™ filter element, clean the regular filter, and repeat start up procedure. The regular filter should be replaced at least once every year.

*SPECIAL NOTE:

We recommend a minimum level of 1.0 ppm residual chlorine be maintained in swim spa water. Always refer to the chemical manufacturer’s dosage recommendations listed on the container.

When adding chlorine or non-chlorine shock/oxidizer always broadcast across the water while the pumps are running.

The quantities of sanitizer and non-chlorine oxidizer shown in this manual are for 500 gallon swim spas and may have to be adjusted depending on the actual amount of water that your swim spa holds. See the specifications section of this manual for the correct gallons of your swim spa.

The concentration of active ingredients in swim spa chemicals varies by manufacturer. Swim spa chemicals are the same as spa chemicals. The amounts of sanitizer suggested in this manual are based on swim spa chemicals that have the active ingredient percentages listed below:

Chlorine	Non-Chlorine Shock/ Oxidizer
Active ingredient:	Active ingredient:
Sodium dichlor 99%	Potassium peroxymonosulfate 42.8%
Other ingredients..... 1%	Inert ingredients 57.2%
Total..... 100%	Total..... 100%

WATER QUALITY MAINTENANCE SCHEDULE - ECO PUR™ (CONTINUED)

AFTER EACH USE

Add 1 ounce of non-chlorine shock/oxidizer* or 1/2 ounce of chlorine* to the swim spa water.

AS NEEDED

If water looks hazy, check PH and Total Alkalinity, and treat with 1 ounce of chlorine*. Always refer to the chemical manufacturer's dosage recommendations listed on the container.

These are general recommendations for water quality maintenance that may vary by usage and or bather load. Depending on bather load and frequency of use, drain and refill times may vary as well as the frequency of cleaning your filters.

A defoamer may be used when excessive foaming occurs. Over use of a defoamer will result in cloudy, milky water.

USE ONLY SWIM SPA CHEMICALS

Do not use chemicals designed for use in swimming pools.

With a swim spa you are working with a small volume of hot water compared to a large volume of relatively cool water in a swimming pool. Because of this chemicals will have a shorter life span and bacteria can grow more quickly than in a swimming pool. A swim spa is less forgiving than a pool and requires that whatever is put into it have a pH as close to neutral as possible. That is why only chemicals made for swim spas or spas should be used. Always refer to the chemical manufacturer's dosage recommendations listed on the container.

*SPECIAL NOTE:

We recommend a minimum level of 1.0 ppm residual chlorine be maintained in swim spa water. Always refer to the chemical manufacturer's dosage recommendations listed on the container.

When adding chlorine or non-chlorine shock/oxidizer always broadcast across the water while the pumps are running.

The quantities of sanitizer and oxidizer shown in this manual are for 500 gallon swim spas and may have to be adjusted depending on the actual amount of water that your swim spa holds. See the specifications section of this manual for the correct gallons of your swim spa.

The concentration of active ingredients in swim spa chemicals varies by manufacturer. Swim spa chemicals are the same as spa chemicals. The amounts of sanitizer suggested in this manual are based on swim spa chemicals that have the active ingredient percentages listed below:

Chlorine	Non-Chlorine Shock/ Oxidizer
Active ingredient:	Active ingredient:
Sodium dichlor 99%	Potassium peroxymonosulfate 42.8%
Other ingredients..... 1%	Inert ingredients 57.2%
Total..... 100%	Total..... 100%

SWIM SPA WATER MAINTENANCE TROUBLE-SHOOTING GUIDE

PROBLEM	POSSIBLE CAUSES	HOW TO FIX IT
Chlorine / Bromine Odor	• Excessive Chlorine or bromine levels	• Shock water with non-chlorine shock treatment
	• Low pH	• Adjust pH if necessary
Water Odor	• Low levels of sanitizer	• Shock water with non-chlorine shock treatment or adjust sanitizer levels
	• pH out of range	• Adjust pH level if necessary
	• Bacteria or algae growth	• Adjust sanitizer if necessary
Cloudy Water	• Dirty filters or inadequate filtration	• Clean filters and adjust filtration times
	• Water chemistry not balanced	• Adjust chemistry levels
	• Suspended particles or organic materials	• Add swim spa clarifier (see dealer)
	• Old water	• Change swim spa water
Scum Ring Around Swim Spa	• Build up of oils, dirt and organic elements	• Wipe off with a clean towel add an enzyme product.
Eye / Skin Irritation	• Unsanitary water	• Shock swim spa with non-chlorine shock
	• Free chlorine level above 5 ppm	• Allow level to drop below 5 ppm
	• Poor sanitizer / pH levels	• Adjust according to swim spa test strip results
Foaming	• High levels of body oils, lotions, soap, etc.	• Add small amount of defoamer

RECOMMENDED LEVELS OF CHEMICAL

Chlorine 1.0 - 3.0 ppm

pH 7.2 - 7.8

Total Alkalinity 80 - 150 ppm

Calcium Hardness 180 - 250 ppm

WHY CHEMICALS ARE IMPORTANT IN A SWIM SPA

1. Evaporation:

As water evaporates, only pure water evaporates, leaving the salts, minerals, metals, and any unused chemicals behind. Adding water adds more salts, minerals, and metals. In time, the water can become saturated with these dissolved solids and can cause stains or scale to form on the walls of the swim spa or a scale build up inside the equipment. Colored or cloudy water, and possible corrosion of plumbing and fittings may also occur.

2. Heat:

Heat causes much quicker evaporation and also will cause minerals and metals to precipitate out of solution.

3. Air:

Dust and airborne dirt particles are introduced into the swim spa.

4. Environment:

The environment surrounding the swim spa can also impact the water quality. Items such as pollen, grass, sand, dirt, lawn fertilizer, airborne dust, insects, leaves, and pets can all affect the water quality of the swim spa.

Remember:

The maintenance routines set forth in this manual may need to be adjusted depending on how much the swim spa is being used.

MAINTENANCE RECOMMENDATIONS

Your swim spa requires periodic draining and cleaning to ensure a safe, healthy environment. It is recommended that you clean your swim spa at least every 180 days. Heavy bather load will require cleaning it more often.

DRAIN YOUR SWIM SPA • See page 14.

CLEAN YOUR SWIM SPA SURFACE

- With a soft cloth, wipe down the swim spa surface with a non-abrasive swim spa surface cleaner that may be purchased through your local dealer. Do not use paper towels. Be sure to rinse residue from swim spa surface.
- If your swim spa has developed an oily or chalky residue at the waterline it may require special treatment. Consult your dealer.

CLEAN THE ACRYLIC DIVIDER (Momentum 80)

- The surface should be first flushed with clean water to remove loose abrasive particles. The clear acrylic sheet should then be gently sponged with a mild detergent/water solution and finally rinsed with clean water. Care must be taken not to leave any of the soap residue in the swim spa as it could cause the swim spa water to foam during operation.
- Drying can be done with a clean soft cotton towel. Avoid hard rough cloths or paper towels since they can put fine scratches on the acrylic surface.
- Do not use any aggressive solvents (lacquer thinner, gasoline, acetone and etc.) on the clear acrylic sheet. These products can cause damage to the sheet that may not be visible until days or weeks later.
- Window glass cleaning compounds are not recommended. Cleaning products that contain any type of abrasive material should not be used.

REFILL YOUR SWIM SPA

- When filling the Momentum swim spa always fill the swim side of the unit before filling the spa side.
- Fill the swim spa with water and be sure that water level is above the skimmer opening at the minimum safe water level sticker.
- Refer to the start-up section for specific instructions.

CLEAN YOUR FILTER ELEMENTS

(also reference page 69)

The filter in your swim spa is one of the most important components of your swim spa. It not only is essential for clean water, but also for extending the life of the swim spa equipment. Your filter elements must be cleaned regularly (once a month on average) with normal swim spa use. With heavy use, they will need to be cleaned more often.

- The filter elements are one of the most important components of your swim spa. Not only are they essential for clean water, but they also extend the life of the swim spa equipment. Your filter elements should be cleaned on a regular basis, once a month on average with normal usage. With heavy use the filters may need to be cleaned more often.
- Turn off the swim spa before servicing filters. Never leave to the swim spa running when removing the filters. Debris can be pulled into the plumbing system and cause unwarranted damage.
- With a garden hose, spray each element under pressure. Periodically, the elements need to be soaked in a filter cleaner compound. Check with your dealer for details on cleaning and/or filter replacement recommendations. Do not soak the Eco Pur filter cartridge in any cleaners.
- Replace filter elements.
- Be sure water level is adequate.
- Turn swim spa on.

CARE OF YOUR SWIM SPA PILLOWS

- Your swim spa pillows need to be rinsed periodically to remove any chemical residue. This should help to eliminate pillows becoming stiff and discolored.
- If the swim spa will not be used for a period of time, the pillows should be removed to extend their useful life.

NOTE: Do not cover the swim spa for 15 minutes after adding chemicals as the off gas can cause unwarranted damage.

MAINTENANCE RECOMMENDATIONS

STAINLESS STEEL

Master Spas uses stainless steel in a number of our swim spas. Its lasting beauty and resistance to corrosion make it an excellent material for handrails and jets faces.

With the proper care it will keep its luster for many years. All stainless steel can corrode given the right circumstances so we have provided a guide to help you keep the stainless components in your swim spa looking nice.

Stainless steel derives its ability to resist corrosion by forming a very thin transparent coating on the surface when exposed to oxygen. This coating can be damaged by abrasive materials such as steel wool, sand paper, and other cleaning materials that are abrasive. Chlorine salts, sulfides, or other rusting metals can also erode this thin coating exposing the metal to corrosion.

The best defense to combat corrosion on stainless steel components in your swim spa is make sure that it is kept clean and free of any chemical build up.

Always:

- Clean frequently with clear clean water.
- Remove any rust spots as soon as they appear with vinegar or a brass, silver, or chrome cleaner.
- Use a good car cleaning wax for extra protection.

Never:

- Clean with mineral acids or bleaches.
- Clean with steel wool or any other abrasive material.
- Leave in contact with iron, steel any other metals.

NOTE: Failure to take proper care of the stainless steel fixture could result with them rusting. Rusting is not covered by the warranty.

NOTE: Do not cover the swim spa for 15 minutes after adding chemicals as the off gas can cause unwarranted damage.

WINTERIZING YOUR SWIM SPA

Your swim spa is designed to be used year round in any type of climate.

* However, if you decide you don't want to use your swim spa in the winter, you must drain it and follow the winterizing steps listed below:

1. Due to the physical size of the swim spa, we recommend draining your swim spa with a submersible sump pump. Draining your swim spa with a conventional swim spa drain is not a reasonable option.
2. Use a shop vac to get all standing water out of your unit.
3. Remove access panels from equipment area.
4. Loosen all pump unions
5. Remove winterizing plug from face of the pump(s) where applicable.
6. Using your shop vac in a blowing mode, insert the hose into the nozzle of each jet and blow the trapped water from the lines into the interior of the swim spa.
7. After this is completed, use the shop vac to remove any standing water in the swim spa and in the equipment area.
8. Clean the swim spa with a soft cloth and a non-abrasive swim spa surface cleaner.
9. Replace access panels.
10. Cover swim spa to prevent water from entering the swim spa.

* If you decide to winterize your swim spa, we recommend that you periodically check the swim spa throughout the winter to assure water is not entering the swim spa through or around the swim spa cover.

* *Disclaimer: Master Spas does not recommend winterizing your swim spa. If you choose to do so, any damage that may result is not covered under the swim spa warranty.*

SPECIFICATIONS

	Swim Spa Dimensions	Electrical Requirements	Water Capacity (gallons)	Weight Dry/Full (lbs.)	Number of Pumps	Jet Count
Momentum 80	231"x 94"x 51"	240V 80A	2,040	2,740 / 19,672	3 pumps 1 propulsion system	45
Momentum 80 D	231"x 94"x 60"	240V 80A	2,270	2,900 / 21,741	3 pumps 1 propulsion system	45
Force	201"x 94"x 51"	240V 50A	1,925	2,700 / 18,735	2 pumps 1 propulsion system	41
Impact	174"x 94"x 51"	240V 50A	1,525	2,460 / 15,117	2 pumps 1 propulsion system	51
Signature	215"x 94"x 60"	240V 50A	2,500	3,240 / 24,000	2 pumps 1 propulsion system	39
Signature S	215"x 94"x 60"	240V 50A	2,300	3,290 / 22,400	2 pumps 1 propulsion system	33



THE MAIN SCREEN



SWIM SPA STATUS

Important information about swim spa operation can be seen quickly from the Main Screen.

The most important features, including Set Temperature adjustment, can be accessed from this screen.

The actual water temperature can be seen in large text and the desired, or Set Temperature, can be selected and adjusted.

Time-of-day, Ozone operation and Filter Operation status is available, along with other messages and alerts.

High Temperature Range vs. Low Temperature Range is indicated in the upper right corner.

The Jets Icon in the center will indicate when a pump is running and also the heater function.

A Lock icon is visible if the panel or settings are locked.

The Menu choices on the right can be selected and the screen will change to show more detailed controls or programming functions.

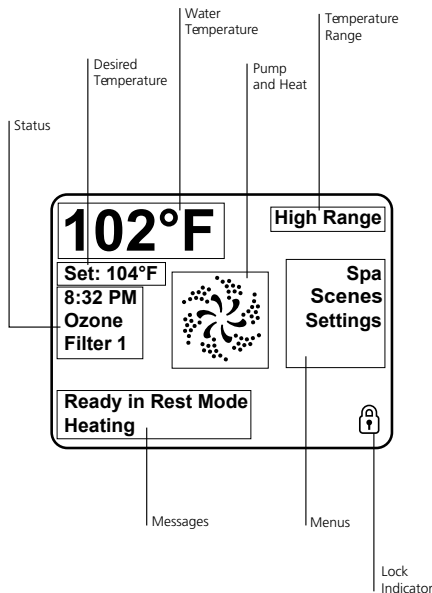

THE MAIN SCREEN

NAVIGATION

Navigating the entire menu structure is done by touching the display on areas that are highlighted white.

When a text item changes to white during navigation, that indicates the item is selected for action.

The only item that can be changed on the left side of the Main Screen is the Set Temperature. Touch the temperature display to change the Set Temperature. The Set Temperature can then be adjusted with the up and down buttons. The new setting will automatically be saved when you exit the screen.

On the right side of the screen, the menu selections can be selected by touching the screen in any area of white text. Selecting one of these items will change to a different screen with additional controls.

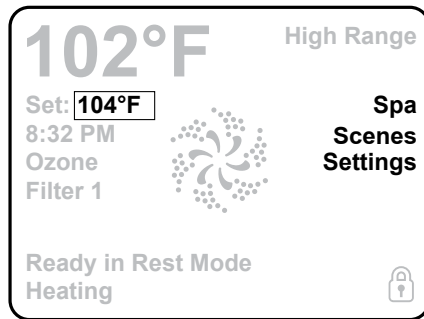

MESSAGES

At the bottom of the screen, messages may appear at various times. Some of these messages must be dismissed by the user (see page 46).

PRESS-AND-HOLD

If an Up or Down button is pressed and held when the Set Temperature is selected, the temperature will continue to change until the button is released, or the Temperature Range limits are reached.

THE SPA SCREEN

ALL EQUIPMENT ACCESS

The Spa Screen shows all available equipment to control, as well as other features, in one easy-to-navigate screen. The display shows icons that are related to the equipment installed on a particular swim spa model, so this screen may change depending on the swim spa.

Touch a button to select an individual device. The device that is chosen is highlighted with a white outline.

Some devices, like pumps, may have more than one ON state, so the icon will change to reflect the state that the equipment is in. Below are some examples of 2-speed Pump indicators.



Jets Off



Jets Low



Jets High

If the swim spa has a 24 hour Circ Pump, a Circ Pump Icon will appear to indicate its activity, but outside of Priming Mode, the 24 hour Circ Pump cannot be controlled directly.

NOTE: The icon for the 24 hour pump (if so equipped) that is associated with the heater will have a red glow in the center when the heater is running.

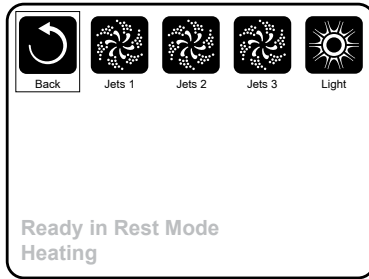

SCENES

The scenes area will allow you to preset any of the devices to operate when the scene is activated. There are four different scenes that can be preset. For example if you would like all of the pumps to turn on at the same time: turn on the pumps, access the scenes area and highlight #1. Once this is set anytime you highlight the #1 scene all of the pumps will activate. To store a specific scene tap and hold the highlighted scene for 5 seconds until the display shows "scene stored" in the bottom left corner.

THE SETTINGS SCREEN

TOUCHING A “BUTTON”

When instructions are given to “touch a button” any of the following can be done:

- Navigate to the desired item on any Screen. Touch the specific setting to make a change. The arrow keys displayed on the left side of the screen will allow you to scroll through the available options.

PROGRAMMING, ETC.

The Settings Screen is where all programming and other swim spa behaviors are controlled.

This screen has several features that can be acted on directly. These features include Temp Range, Heat Mode, and Invert Panel. Touch the specific setting to make the change.

All other menu items (with an arrow pointing to the right) go to another level in the menu.

TOUCH-AND-HOLD

The up and down buttons on the left side of the screen allow you to scroll through the different setting options.

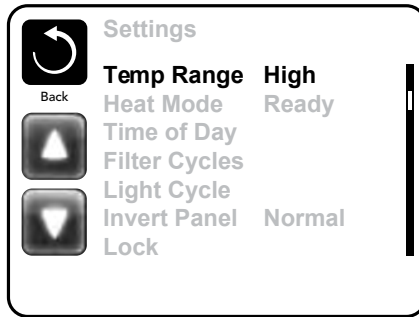

DUAL TEMPERATURE RANGES (HIGH VS. LOW)

This system incorporates two temperature range settings with independent set temperatures. The specific range can be selected on the Settings screen and is visible on the Main Screen in the upper right corner of the display.

These ranges can be used for various reasons, with a common use being a “ready to use” setting vs. a “vacation” setting. Each range maintains its own set temperature as programmed by the user. This way, when a range is chosen, the swim spa will heat to the set temperature associated with that range.

High Range can be set between 80°F and 104°F.

Low Range can be set between 50°F and 99°F.

Freeze Protection is active in either range.

THE SETTINGS SCREEN – CONTINUED

HEAT MODE – READY VS. REST

In order for the swim spa to heat, a pump needs to circulate water through the heater.

REST Mode will only allow heating during programmed filter cycles.

Ready Mode will allow heating any time the water temperature drops below the set temperature.

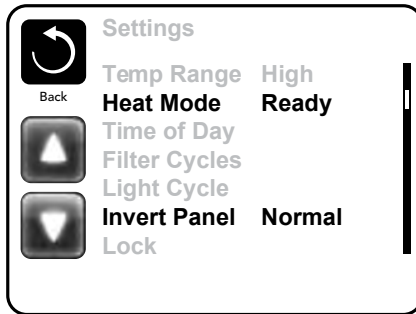

READY-IN-REST MODE

READY/REST appears in the display if the swim spa is in Rest Mode and the Jets 1 Button is touched. It is assumed that the swim spa is being used and will heat to set temperature. After 1 hour, the System will revert to Rest Mode. This mode can also be reset by entering the Settings Menu and changing the Heat Mode.

FILL IT UP!

PREPARATION AND FILLING

Fill the swim spa to its correct operating level. Be sure to open all valves and jets in the plumbing system before filling to allow as much air as possible to escape from the plumbing and the control system during the filling process.

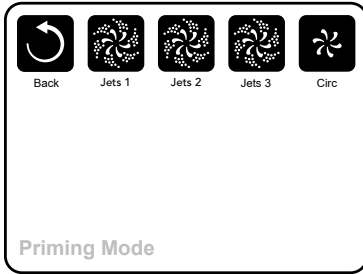

PRIMING MODE

After the initial start-up sequence, the control will enter Priming Mode and display a Priming Mode screen. Only pump icons appear on the priming mode screen. The system will automatically begin normal heating and filtering at the end of the priming mode, which lasts 4-5 minutes. During the priming mode, the heater is disabled to allow the priming process to be completed without the possibility of energizing the heater under low-flow or no-flow conditions. Nothing comes on automatically, but the pump(s) can be activated by touching the "Jet" buttons.

Manually exit Priming Mode by touching the "Back" Button.

PRIMING THE PUMPS

As soon as the Priming Mode screen appears on the panel, touch the "Jets 1" button once to start Pump 1 in low-speed and then again to switch to high-speed. Also, touch the other pumps, to turn them on. The pumps should be running in high-speed to facilitate priming. If the pumps have not primed after 2 minutes, and water is not flowing from the jets in the swim spa, do not allow the pumps to continue to run. Turn off the pumps and repeat the process. Note: Turning the power off and back on again will initiate a new pump priming session. Sometimes momentarily turning the pump off and on will help it to prime. Do not do this more than 5 times. If the pump(s) will not prime, shut off the power to the swim spa and call for service.

Important: A pump should not be allowed to run without priming for more than 2 minutes. Under NO circumstances should a pump be allowed to run without priming beyond the end of the 4-5 minute priming mode. Doing so may cause damage to the pump and cause the system to energize the heater and go into an overheat condition.

EXITING PRIMING MODE

You can manually exit Priming Mode by touching the "Back" button on the Priming Mode Screen. Note that if you do not manually exit the priming mode as described above, the priming mode will be automatically terminated after 4-5 minutes. Be sure that the pump(s) have been primed by this time.

Once the system has exited Priming Mode, the top-side panel will display the Main Screen, but the display will not show the temperature yet, as shown below. This is because the system requires approximately 1 minute of water flowing through the heater to determine the water temperature and display it.

--°F-- --°C

SWIM SPA BEHAVIOR

PUMPS

On the Spa Screen, touch a "Jets" button once to turn the pump on or off, and to shift between low- and high-speeds if equipped. If left running, the pump will turn off after a time-out period. The pump 1 low-speed will time out after 30 minutes. The high-speed will time-out after 15 minutes.

FILTRATION AND OZONE

The system is factory-programmed with one filter cycle that will run in the evening (assuming the time-of-day is properly set) when energy rates are often lower. The filter time and duration are programmable. (See page 41) A second filter cycle can be enabled as needed.

At the start of each filter cycle, the pumps will run briefly to purge the plumbing to maintain good water quality.

FREEZE PROTECTION

If the temperature sensors within the heater detect a low enough temperature, then the pumps automatically activate to provide freeze protection. The pumps will run either continuously or periodically depending on conditions. If the temperature sensors detect a drop to below 44°F/6.7°C within the heater, the pump will automatically activate to provide freeze protection. The equipment stays on until 4 minutes after the sensors detect that the swim spa temperature has risen to 45°F/7.2°C or higher. During freeze protection the heater will not be activated.

CLEAN-UP CYCLE (OPTIONAL)

When a pump or blower is turned on by a button touch, a clean-up cycle begins 30 minutes after the pump is turned off or times out. The pump and the ozone generator will run for 30 minutes or more, depending on the system.

TIME-OF-DAY

BE SURE TO SET THE TIME-OF-DAY

Setting the time-of-day is important for determining filtration times and other background features.

“Set Time” will appear on the display if no time-of-day is set in the memory.

On the Settings Screen, select the Time-of-Day line. On the Time-of-Day screen, simply touch the time to select the Hour, Minutes, AM/PM and 12/24 Hour segments. Use the Up and Down Buttons to make changes.

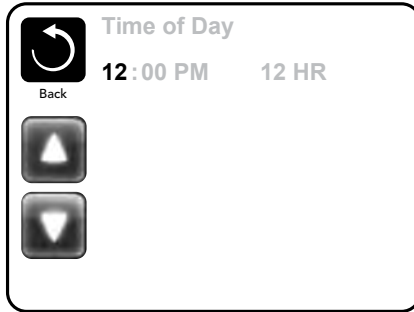

SAVING SETTINGS

The Time-of-Day screen is a simple, editable screen that illustrates a feature of the control that applies to all other editable screens as well.

When changes are made, touch the back button to save the setting or touch the cancel icon to exit without saving changes.

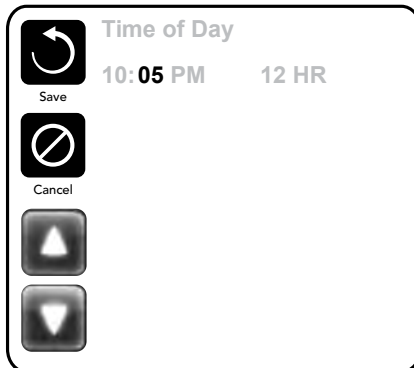

NOTE:

If power is interrupted to the system, Time-of-Day will be maintained for several days.

ADJUSTING FILTRATION

MAIN FILTRATION

Using the same navigation and adjustment as Setting the Time, Filter Cycles are set using a start time and a duration. Each setting can be adjusted in 15-minute increments. The panel calculates the end time and displays it automatically.

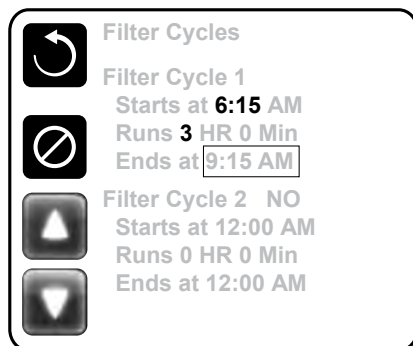
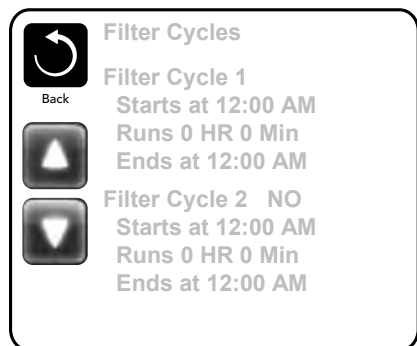

FILTER CYCLE 2 - OPTIONAL FILTRATION

Filter Cycle 2 is OFF by default.

Simply touch the Filter Cycle 2 line in the highlighted area, and when "NO" is highlighted, press Up or Down to toggle Filter Cycle 2 on and off. When Filter Cycle 2 is ON, it can be adjusted in the same manner as Filter Cycle 1.

It is possible to overlap Filter Cycle 1 and Filter Cycle 2, which will shorten overall filtration by the overlap amount.

PURGE CYCLES

In order to maintain sanitary conditions, as well as protect against freezing, the system will purge water from the respective plumbing by running briefly at the beginning of each filter cycle.

If the Filter Cycle 1 duration is set for 24 hours, enabling Filter Cycle 2 will initiate a purge when Filter Cycle 2 is programmed to begin.

RESTRICTING OPERATION

The control can be restricted to prevent unwanted use or temperature adjustments.

Locking the Panel prevents the controller from being used, but all automatic functions are still active.

Locking the Settings allows Jets and other features to be used, but the Set Temperature and other programmed settings cannot be adjusted.

Settings Lock allows access to a reduced selection of menu items. These include Set Temperature, Invert, Lock, Utilities, Information and Fault Log. They can be seen, but not changed or edited.

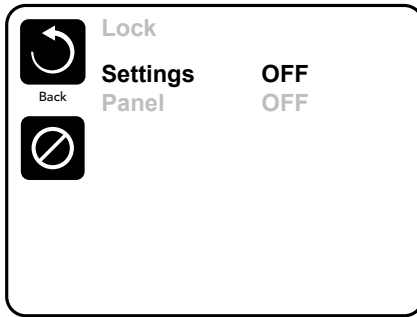

UNLOCKING

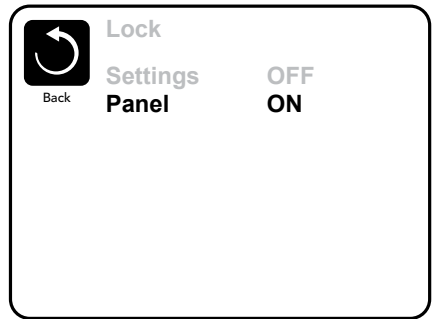

When the system is locked an icon will appear in the lower right hand corner of the display.

To unlock, touch the "Unlock" text on the main screen. You can then touch the "Settings" or "Panel" text to highlight the text. Next touch the display screen in the center and hold it for 5 seconds. The text will show that the unlocking has been completed. Touch the back button to exit and save.

ADDITIONAL SETTINGS

HOLD MODE

Hold Mode is used to disable the pumps during service functions like cleaning or replacing the filter. Hold Mode will last for 1 hour unless the mode is exited manually. If swim spa service will require more than an hour, it may be best to simply shut down power to the swim spa.

UTILITIES

The Utilities Menu contains the following:

A/B Temps

When this is set to On, the A/B temperature will display in the top right corner indicating the temperature of the sensors mounted in the heater.

Fault Log

The Fault Log is a record of the last 24 faults that can be reviewed by a service tech.

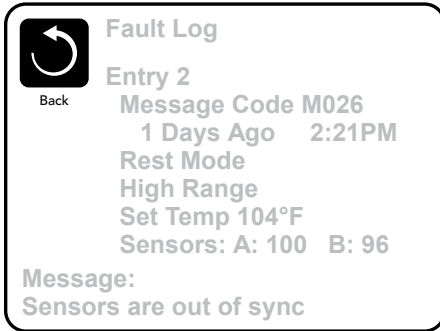

GFCI Test

When this feature is activated the control system will simulate a ground fault problem and trip the main GFCI circuit breaker that provides power to the swim spa and the system will shut down completely. You must then reset the main GFCI breaker for the system to begin operating again.

ADDITIONAL SETTINGS

PREFERENCES

The Preferences Menu allows the user to change certain parameters based on personal preference.

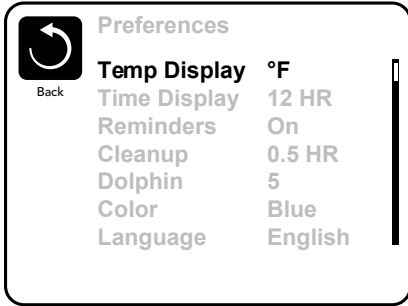

Temp Display

Change the temperature between Fahrenheit and Celsius.

Time Display

Change the clock between 12 hr and 24 hr display.

Reminders

Turn the reminder messages (like "Clean Filter") On or Off.

Dolphin

The Dolphin control is not available on this control system.

Color

Pressing the Select Button when Color is highlighted will cycle through 5 background colors available in the control.

Language

Change the language displayed on the panel.

INFORMATION

SYSTEM INFORMATION

The System Information Menu displays various settings and identification of the particular system. As each item in the menu is highlighted, the detail for that item is displayed at the bottom of the screen. These settings are for information only and cannot be changed.

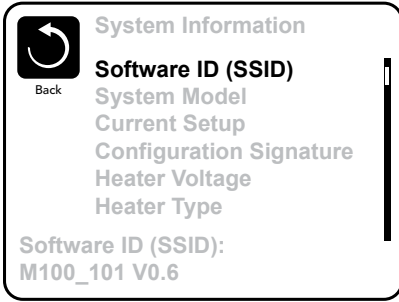

Software ID (SSID)

Displays the software ID number for the System.

System Model

Displays the Model Number of the System.

Current Setup

Displays the currently selected Configuration Setup Number.

Configuration Signature

Displays the checksum for the system configuration file.

Heater Voltage (Feature not used on CE rated systems.)

Displays the operating voltage configured for the heater.

Heater Wattage as Configured in Software (CE Systems Only.)

Displays a heater kilowatt rating as programmed into the control system software (1-3 or 3-6).

Heater Type

Displays a heater type ID number.

Dip Switch Settings

Displays a number that represents the DIP switch positions of S1 on the main circuit board.

Panel Version

Displays a number of the software in the topside control panel.

GENERAL MESSAGES

Most messages and alerts will appear at the bottom of the normally used screens. Several alerts and messages may be displayed in a sequence.

Some messages can be reset from the panel. Messages that can be reset will appear with a “right arrow” at the end of the message. This message can be selected by touching the screen at the text.

---°F- --°C

WATER TEMPERATURE IS UNKNOWN

After the pump has been running for 1 minute, the temperature will be displayed.

POSSIBLE FREEZING CONDITION

A potential freeze condition has been detected. All pumps are activated.

In some cases, pumps may turn on and off and the heater may operate during Freeze Protection.

This is an operational message, not an error indication.

THE WATER IS TOO HOT

The system has detected a swim spa water temp of 110°F (43.3°C) or more, and swim spa functions are disabled. System will auto reset when the swim spa water temp is below 108°F (42.2°C). Check for extended pump operation, high ambient temperature, or prolonged filter cycles.

* This message can be reset from the topside panel.

HEATER-RELATED MESSAGES

THE WATER FLOW IS LOW

There may not be enough water flow through the heater to carry the heat away from the heating element. Heater start up will begin again after about 1 min. See "Flow Related Checks" below.

THE WATER FLOW HAS FAILED*

There is not enough water flow through the heater to carry the heat away from the heating element and the heater has been disabled. See "Flow Related Checks" below. After the problem has been resolved, you must press any button to reset and begin heater start up.

THE HEATER MAY BE DRY*

Possible dry heater, or not enough water in the heater to start it. The swim spa is shut down for 15 min. Press any button to reset the heater start-up. See "Flow Related Checks" below.

THE HEATER IS DRY*

There is not enough water in the heater to start it. The swim spa is shut down. After the problem has been resolved, you must clear the message to restart heater start up. See "Flow Related Checks" below.

THE HEATER IS TOO HOT*

One of the water temp sensors has detected 118°F (47.8°C) in the heater and the swim spa is shut down. You must clear the message when water is below 108°F (42.2°C). See "Flow Related Checks" below.

FLOW-RELATED CHECKS

Check for low water level, clogged filters, suction flow restrictions, closed valves, trapped air, too many closed jets and pump prime.

On some systems, even when swim spa is shut down by an error condition, some equipment may occasionally turn on to continue monitoring temperature or if freeze protection is needed.

* This message can be reset from the topside panel.

SENSOR-RELATED MESSAGES

SENSORS ARE OUT OF SYNC

The temperature sensors MAY be out of sync by 2°F or 3°F. Call for Service.

SENSORS ARE OUT OF SYNC -- CALL FOR SERVICE*

The temperature sensors ARE out of sync. The fault above has been established for at least 1 hour. Call for Service.

SENSOR A FAULT, SENOR B FAULT

A temperature sensor or sensor circuit has failed. Call for Service.

MISCELLANEOUS MESSAGES

COMMUNICATIONS ERROR

The control panel is not receiving communication from the System. Call for Service.

TEST SOFTWARE INSTALLED

The Control System is operating with test software. Call for Service.

°F OR °C IS REPLACED BY °T

The Control System is in Test Mode. Call for Service.

* This message can be reset from the topside panel.

SYSTEM-RELATED MESSAGES

PROGRAM MEMORY FAILURE*

At Power-Up, the system has failed the Program Checksum Test. This indicates a problem with the firmware (operation program) and requires a service call.

THE SETTINGS HAVE BEEN RESET (PERSISTENT MEMORY ERROR)*

Contact your dealer or service organization if this message appears on more than one power-up.

THE CLOCK HAS FAILED*

Contact your dealer or service organization.

CONFIGURATION ERROR (SWIM SPA WILL NOT START UP)

Contact your dealer or service organization.

A PUMP MAY BE STUCK ON

Water may be overheated. POWER DOWN THE SWIM SPA. DO NOT ENTER THE WATER. Contact your dealer or service organization.

HOT FAULT

A Pump Appears to have been Stuck ON when swim spa was last powered

POWER DOWN THE SWIM SPA. DO NOT ENTER THE WATER. Contact your dealer or service organization.

* This message can be reset from the topside panel.

PROPULSION SYSTEM

MOMENTUM 80, SIGNATURE, FORCE AND IMPACT



The Propulsion System (Momentum 80, Signature, Force, Impact)

The unique belt-driven propulsion system provides the most consistent flow of water to swim and exercise against. This propulsion system is controlled by the revolutionary SNAPP control system which allows you to tailor your swim work out.

The easy to operate control panel allows you not only to control the speed of the water flow but also to tailor your swim work out to your own comfort level.

Optional Exercise Equipment All

The optional exercise equipment package makes it easy to exercise in your own back yard. There are shell mounted clips that are used to fasten the rowing equipment to the swim spa. These clips are located along the sides of your swim spa next to the grab rails that are placed around the perimeter of the swim area. Also available are ankle fins and exercise bells that will allow you to do resistance training. See your Master Spas dealer for details.

NOTE: DO NOT LEAVE EXERCISE EQUIPMENT INSIDE THE SWIM SPA WHEN NOT IN USE. DO NOT LEAVE EXERCISE EQUIPMENT OUTSIDE EXPOSED TO ULTRA VIOLET RAYS. FAILURE TO FOLLOW THE ABOVE GUIDELINES COULD RESULT IN INJURY.

SWIM CONTROL OPERATION



1. **Up** button increases the swim number (speed).
2. **Down** button lowers the swim number (speed).
3. **Swim Number** indicates the speed of the propulsion drive. Speed is indicated in numbers from 1 to 100.
4. **Mode** reference used during workouts to calculate calorie counts when used with SNAPP APP. During manual operation this setting can be changed by touching the highlighted text but you will not see a change in the swim current.
5. **Start** button starts the propulsion drive after a 5 second delay. This delay allows the swimmer time to get into position and prepare for the swim current.
6. **Pause** button allows you to momentarily pause the operation of the propulsion drive. Whenever the drive is restarted there will be a 5 second delay before it resumes operation.
7. **User** workout selection allows you to choose between the default user and any custom users that have been added through the SNAPP APP.
8. **Smart Workouts** can be selected from here by touching the highlighted area. Please refer to the Smart Workout Reference guide included with the spa information materials. From there you can select Smart Workouts that will allow you exercise with preprogrammed workouts that control the Wave Propulsion Systems.
9. **Duration** shows the duration of the complete workout.
10. **Elapsed Time** will be displayed in a manual mode workout and indicates the total time that the propulsion drive has been running in the current workout and is only active in manual mode.
Remaining Time will be displayed in a Smart Workout and indicates how much time is left to complete the workout.
11. **Step in Cycle** indicates the time you have been in a specific workout step.
12. **Temperature** of water in swim spa
13. **Time** of day.
14. **Lock APP** allows you to restrict control of the propulsion system from the Swim Number App (SNAPP)

Note: If the topside control touch screen becomes erratic or will not function correctly, it may need to be synced to the main control pack. To sync the topside control hold the pause button until the display resets and displays (Synchronizing) in the lower left hand corner of the display.

BEGINNER FITNESS WORKOUT - 9 MIN. 30 SEC.

Step	Mode	Seconds	*Wave Swim Number	*Wave XP Swim Number	*Wave XP Pro Swim Number	**Recommended Exercise
1	Jog	15	1	1	1	Walking Forward
2	Jog	15	1	1	1	Walking Backward
3	Jog	15	1	1	1	Walking Sideways
4	Jog	15	1	1	1	Marching
5	Jog	15	1	1	1	Heel to Butt
6	Jog	15	1	1	1	Straight Leg Rise
7	Jog	15	1	1	1	Switch Legs
8	Jog	30	1	1	1	Trailing Forward/Back (Both Flow Directions)
9	Jog	45	1	1	1	Files
10	Jog	45	1	1	1	Push/Pulls
11	Jog	45	1	1	1	Push Downs
12	Jog	45	1	1	1	Hip Flexion/Extension
13	Jog	45	1	1	1	Hip Abduction/Adduction
14	Jog	45	1	1	1	Core rotations. 2 hand start with isometric hold
15	Jog	45	1	1	1	Continue core rotations with Forward/Side Flow
16	Jog	120	32	12	11	Gentle jog into flow

*Swim Number speed depends on propulsion system equipped in swim spa.

**See Swim Number App for iPad or exercise book for detailed exercise instructions.

INTERMEDIATE FITNESS WORKOUT - 15 MIN. 15 SEC.

Step	Mode	Seconds	*Wave Swim Number	*Wave XP Swim Number	*Wave XP Pro Swim Number	**Recommended Exercise
1	Jog	25	1	1	1	Walking forward
2	Jog	25	1	1	1	Walking backward
3	Jog	25	1	1	1	Walking sideways (with both arms back)
4	Jog	25	1	1	1	Marching
5	Jog	25	1	1	1	Heel to butt with UE
6	Jog	25	1	1	1	Straight leg rise
7	Jog	25	1	1	1	Switch legs
8	Jog	25	1	1	1	Straight leg rise out
9	Jog	25	1	1	1	Switch legs
10	Jog	45	1	1	1	Flies forward
11	Jog	45	1	1	1	Switch legs
12	Jog	45	1	1	1	Flies side
13	Jog	45	1	1	1	Switch legs
14	Jog	45	1	1	1	Push/Pulls
15	Jog	45	1	1	1	Switch legs
16	Jog	45	1	1	1	Push downs
17	Jog	45	1	1	1	Switch legs
18	Jog	45	1	1	1	Power swings
19	Jog	45	1	1	1	Switch legs
20	Jog	45	1	1	1	Soccer kicks
21	Jog	45	1	1	1	Switch legs
22	Swim	30	76	56	48	Pikes in to flow
23	Jog	120	43	23	20	Running forward (no bells or fins)

*Swim Number speed depends on propulsion system equipped in swim spa.

**See Swim Number App for iPad or exercise book for detailed exercise instructions.

ADVANCED FITNESS WORKOUT - 27 MIN.

Step	Mode	Seconds	*Wave Swim Number	*Wave XP Swim Number	*Wave XP Pro Swim Number	**Recommended Exercise
1	Jog	45	1	1	1	Walking forward
2	Jog	45	1	1	1	Walking forward
3	Jog	45	1	1	1	Walking sideways (one arm forward, one arm back)
4	Jog	45	1	1	1	Marching
5	Jog	45	1	1	1	Heel to butt with UE
6	Jog	45	1	1	1	Straight leg rise
7	Jog	45	1	1	1	Switch legs
8	Jog	45	1	1	1	Straight leg rise out
9	Jog	45	1	1	1	Switch legs
10	Jog	45	1	1	1	Straight leg rise in
11	Jog	45	1	1	1	Switch legs
12	Jog	75	1	1	1	Flies forward
13	Jog	75	1	1	1	Switch legs
14	Jog	75	1	1	1	Flies side
15	Jog	75	1	1	1	Switch legs
16	Jog	75	1	1	1	Alternating push/pulls
17	Jog	75	1	1	1	Switch legs
18	Jog	75	1	1	1	Alternating push downs
19	Jog	75	1	1	1	Switch legs
20	Jog	75	1	1	1	Power swings
21	Jog	75	1	1	1	Switch legs
22	Jog	75	1	1	1	Soccer kicks
23	Jog	75	1	1	1	Switch legs
24	Swim	45	1	1	1	Ronde De Jambre
25	Jog	60	65	45	39	Sprinting forward
26	Jog	60	65	45	39	Sprinting sideways
27	Jog	60	65	45	39	Sprinting backwards

*Swim Number speed depends on propulsion system equipped in swim spa.

**See Swim Number App for iPad or exercise book for detailed exercise instructions.

BEGINNER TRAINING WORKOUT - 15 MIN.

Step	Mode	Seconds	*Wave Swim Number	*Wave XP Swim Number	*Wave XP Pro Swim Number	**Recommended Exercise
1	Swim	60	54	34	30	Breast stroke
2	Jog	60	54	34	30	Running in place
3	Jog	30	1	1	1	Step-up right leg
4	Jog	30	1	1	1	Step-up left leg
5	Jog	60	65	45	39	Butt kicks
6	Jog	30	1	1	1	Arm circles forward
7	Jog	30	1	1	1	Arm circles backward
8	Jog	60	65	45	39	High knees
9	Jog	60	1	1	1	Row bars
10	Jog	60	65	45	39	Running in place
11	Jog	30	1	1	1	Band (bicep curl) right arm
12	Jog	30	1	1	1	Band (bicep curl) left arm
13	Jog	60	65	45	39	Butt kicks
14	Jog	60	1	1	1	Seated pull rows
15	Jog	60	65	45	39	High knees
16	Jog	30	1	1	1	Band (tricep extension)
17	Swim	60	65	45	39	Breast stroke
18	Swim	30	76	56	48	Body weight
19	Jog	60	43	23	20	Running in place

*Swim Number speed depends on propulsion system equipped in swim spa.

**See Swim Number App for iPad or exercise book for detailed exercise instructions.

INTERMEDIATE TRAINING WORKOUT - 30 MIN.

Step	Mode	Seconds	*Wave Swim Number	*Wave XP Swim Number	*Wave XP Pro Swim Number	**Recommended Exercise
1	Swim	120	54	34	30	Breast stroke
2	Jog	120	54	34	30	Running in place
3	Jog	60	1	1	1	Step-up right leg
4	Jog	60	1	1	1	Step-up left leg
5	Jog	60	65	45	39	Butt kicks
6	Jog	60	1	1	1	Right leg raise
7	Jog	60	1	1	1	Left leg raise
8	Jog	60	1	1	1	Arm circles forward
9	Jog	60	1	1	1	Arm circles backward
10	Jog	60	65	45	39	High knees
11	Jog	60	1	1	1	Band (shoulder press)
12	Swim	60	65	45	39	Breast stroke
13	Jog	60	1	1	1	Band (chest press)
14	Swim	60	54	34	30	Free style swim
15	Jog	60	1	1	1	Band (bicep curl) right arm
16	Jog	60	1	1	1	Band (bicep curl) left arm
17	Swim	60	54	34	30	Free style swim
18	Jog	60	1	1	1	Seated pull rows
19	Jog	60	40	45	39	Running in place
20	Jog	60	1	1	1	Bumb bells push/pull
21	Jog	60	65	45	39	Breast stroke
22	Jog	60	1	1	1	Band (tricep extension)
23	Jog	60	65	45	39	Butt kicks
24	Jog	60	1	1	1	Dumb bells push and squeeze at end
25	Jog	60	65	45	39	High knees
26	Swim	60	76	56	48	Body weight
27	Jog	120	34	14	11	Running in place

*Swim Number speed depends on propulsion system equipped in swim spa.

**See Swim Number App for iPad or exercise book for detailed exercise instructions.

ADVANCED TRAINING WORKOUT - 45 MIN.

Step	Mode	Seconds	*Wave Swim Number	*Wave XP Swim Number	**Recommended Exercise
1	Swim	120	54	34	Breast stroke
2	Jog	120	54	34	Running in place
3	Jog	60	1	1	Step-up right leg
4	Jog	60	1	1	Step-up left leg
5	Jog	60	65	45	Butt kicks
6	Jog	60	1	1	Right leg raise
7	Jog	60	1	1	Left leg raise
8	Jog	60	1	1	Arm circles forward
9	Jog	60	1	1	Arm circles backward
10	Jog	60	65	45	High knees
11	Jog	60	1	1	Band (shoulder press)
12	Swim	120	65	45	Breast stroke
13	Jog	60	1	1	Band (chest press)
14	Swim	120	76	56	Free style swim
15	Jog	60	1	1	Step-up right leg
16	Jog	60	1	1	Step-up left leg
17	Swim	120	65	45	Breast stroke
18	Jog	60	1	1	Band (bicep curl) right arm

Step	Mode	Seconds	*Wave Swim Number	*Wave XP Swim Number	**Recommended Exercise
19	Jog	60	1	1	Band (bicep curl) left arm
20	Swim	120	76	48	Free style swim
21	Jog	60	1	1	Seated pull rows
22	Jog	60	1	1	Arm circles forward
23	Jog	60	1	1	Arm circles backward
24	Swim	120	65	39	Breast stroke
25	Jog	60	1	1	Dumb bells push/pull
26	Swim	120	76	48	Free style swim
27	Jog	60	1	1	Band (tricep extension)
28	Jog	60	1	1	Step-up right leg
29	Jog	60	1	1	Step-up left leg
30	Jog	60	60	39	Butt Kicks
31	Jog	60	1	1	Dumb bells push and squeeze at end
32	Jog	60	1	1	Arm circles forward
33	Jog	60	1	1	Arm circles backward
34	Jog	60	64	39	High knees
35	Swim	60	76	48	Body weight
36	Jog	120	34	11	Running in place

*Swim Number speed depends on propulsion system equipped in swim spa.

**See Swim Number App for iPad or exercise book for detailed exercise instructions.

BEGINNER SWIM WORKOUT - 25 MIN.

Step	Mode	Seconds	*Wave Swim Number	*Wave XP Swim Number	*Wave XP Pro Swim Number	**Recommended Exercise
1	Swim	60	61	41	35	Free Style Swim
2	Swim	60	61	41	35	Kick Chore
3	Swim	60	54	34	30	Catch Up Drill
4	Swim	60	67	47	40	Backstroke
5	Jog	60	1	1	1	Jog in Place
6	Swim	60	67	47	40	Free Style Swim
7	Swim	60	61	41	35	Kick Chore
8	Swim	60	54	34	30	Catch Up Drill
9	Swim	60	67	47	40	Backstroke
10	Jog	60	1	1	1	Jog in Place
11	Swim	60	67	47	40	Free Style Swim
12	Swim	60	61	41	35	Kick Chore
13	Swim	60	54	34	30	Catch Up Drill
14	Swim	60	67	47	40	Backstroke
15	Jog	60	1	1	1	Jog in Place
16	Swim	60	67	47	40	Free Style Swim
17	Swim	60	61	41	35	Kick Chore
18	Swim	60	54	34	30	Catch Up Drill
19	Swim	60	67	47	40	Backstroke
20	Jog	60	1	1	1	Jog in Place
21	Swim	60	67	47	40	Free Style Swim
22	Swim	60	61	41	35	Kick Chore
23	Swim	60	54	34	30	Catch Up Drill
24	Swim	60	67	47	40	Backstroke
25	Swim	60	61	41	35	Free Style Swim

*Swim Number speed depends on propulsion system equipped in swim spa.
 **See Swim Number App for iPad or exercise book for detailed exercise instructions.

INTERMEDIATE SWIM WORKOUT - 25 MIN. 30 SEC.

Step	Mode	Seconds	*Wave Swim Number	*Wave XP Swim Number	*Wave XP Pro Swim Number	**Recommended Exercise
1	Swim	120	54	34	30	Free Style Swim
2	Swim	60	54	34	30	Fly Drill 2-2-2
3	Swim	60	1	1	1	W Fly 5 Strokes Fast + 10 55 FR EZ
4	Swim	120	1	1	1	Free Style Moderate Effort
5	Swim	60	65	45	39	Free Style Hard Effort
6	Jog	30	1	1	1	Jog in Place
7	Swim	60	1	1	1	Fly Drill 2-2-2
8	Swim	60	1	1	1	W Fly 5 Strokes Fast + 10 55 FR EZ
9	Swim	120	1	1	1	Free Style Moderate Effort
10	Swim	60	65	45	39	Free Style Hard Effort
11	Jog	30	1	1	1	Jog in Place
12	Swim	60	65	45	39	Fly Drill 2-2-2
13	Swim	60	1	1	1	W Fly 5 Strokes Fast + 10 55 FR EZ
14	Swim	120	1	1	1	Free Style Moderate Effort
15	Swim	60	65	45	39	Free Style Hard Effort
16	Jog	30	1	1	1	Jog in Place
17	Swim	60	65	45	39	Fly Drill 2-2-2
18	Swim	60	1	1	1	W Fly 5 Strokes Fast + 10 55 FR EZ
19	Swim	120	65	45	39	Free Style Moderate Effort
20	Swim	60	76	56	48	Free Style Hard Effort
21	Swim	120	34	14	11	Free Style Swim

*Swim Number speed depends on propulsion system equipped in swim spa.

**See Swim Number App for iPad or exercise book for detailed exercise instructions.

ADVANCED SWIM WORKOUT - 41 MIN.

Step	Mode	Seconds	*Wave Swim Number	*Wave XP Swim Number	*Wave XP Pro Swim Number	**Recommended Exercise
20	Swim	60	67	47	40	Catchup with Steady Kick
21	Swim	60	80	60	50	Free Style Moderate Effort
22	Swim	60	96	76	65	Free Style Hard Effort
23	Swim	60	67	47	40	KKP Breast Drill
24	Swim	60	96	76	65	Breast Hard
25	Jog	60	1	1	1	Jog in Place
26	Swim	60	61	41	35	EZ Kick
27	Swim	60	67	47	40	Moderate Kick
28	Swim	60	74	54	46	Hard Kick
29	Swim	60	67	47	40	Catchup with Steady Kick
30	Swim	60	80	60	50	Free Style Moderate Effort
31	Swim	60	96	76	65	Free Style Hard Effort
32	Swim	60	67	47	40	KKP Breast Drill
33	Swim	60	96	76	65	Breast Hard
34	Jog	60	1	1	1	Jog in Place
35	Swim	60	61	41	35	EZ Kick
36	Swim	60	67	47	40	Moderate Kick
37	Swim	60	74	54	46	Hard Kick
38	Swim	120	61	41	35	Free Style Swim

Step	Mode	Seconds	*Wave Swim Number	*Wave XP Swim Number	*Wave XP Pro Swim Number	**Recommended Exercise
1	Swim	180	67	47	40	Free Style Swim
2	Swim	60	67	47	40	Catchup with Steady Kick
3	Swim	60	80	60	50	Free Style Moderate Effort
4	Swim	60	96	76	65	Free Style Hard Effort
5	Swim	60	67	47	40	KKP Breast Drill
6	Swim	60	96	76	65	Breast Hard
7	Jog	60	1	1	1	Jog in Place
8	Swim	60	61	41	35	EZ Kick
9	Swim	60	67	47	40	Moderate Kick
10	Swim	60	74	54	46	Hard Kick
11	Swim	60	67	47	40	Catchup with Steady Kick
12	Swim	60	80	60	50	Free Style Moderate Effort
13	Swim	60	96	76	65	Free Style Hard Effort
14	Swim	60	67	47	40	KKP Breast Drill
15	Swim	60	96	76	65	Breast Hard
16	Jog	60	1	1	1	Jog in Place
17	Swim	60	61	41	35	EZ Kick
18	Swim	60	67	47	40	Moderate Kick
19	Swim	60	74	54	46	Hard Kick

*Swim Number speed depends on propulsion system equipped in swim spa.

**See Swim Number App for iPad or exercise book for detailed exercise instructions.

AQUAVIBE BT AUDIO SYSTEM

BUTTON LOCATIONS AND FUNCTIONS

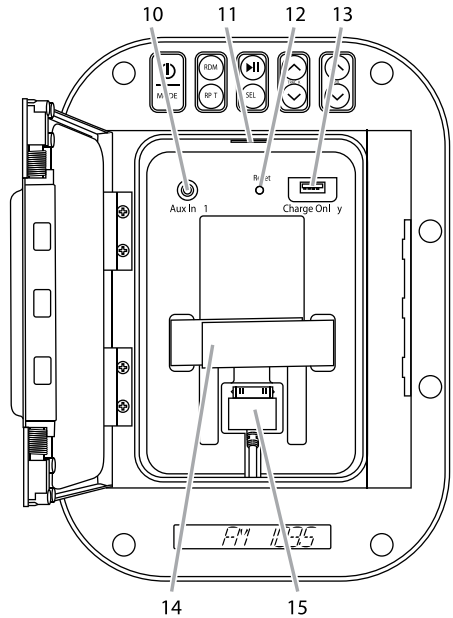
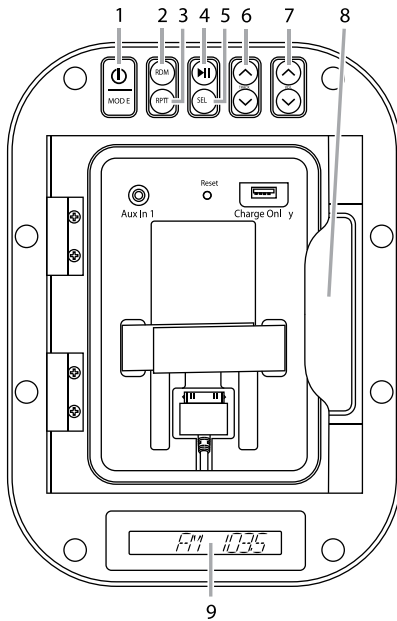

1. Power and Mode Button:

Power Button: Press to turn the entertainment center on. Press and hold the button for 2 seconds to turn the unit off.

Mode Button: Press to select between input sources:

Radio: FM tuner.

iPOD: 30-pin connector. (Can be selected only when connected to a device).

Aux in 1: 3.5mm jack.

Aux in 2: Rear RCA connectors.

Bluetooth: Wireless connectivity.

2. Random Button (RDM): Press the button for random controls in iPOD and Bluetooth modes.

3. Repeat Button (RPT): Press the button for repeat controls in iPOD and Bluetooth modes.

4. Play/Pause Button (▶||):

Radio or Auxiliary Mode: Press to mute the audio.

iPOD or Bluetooth Mode: Press to pause playback.

5. Select Button: Press to toggle between: bass, treble, balance, fader, equalizer, area, loudness and local/distance settings.

6. Track Buttons:

Radio Mode: Press for automatic seek up or seek down of radio stations. Press and hold to activate manual tuning.

iPOD or Bluetooth Mode: Press to select the next or previous tracks.

7. Volume: Press to increase or decrease the volume level.

8. Door Release Handle: Lift up on the door handle to open the door.

9. Display Area: This area displays mode information, in the radio mode the radio frequency and in iPOD and supported Bluetooth modes song information is displayed.

10. 3.5mm Jack: Plug a cable into the 3.5mm jack then into a device (MP3 player or phone) with a 3.5mm socket. The unit will not control the device, it simply allows the audio to be played through the system.

BUTTON LOCATIONS AND FUNCTIONS (CONT.)

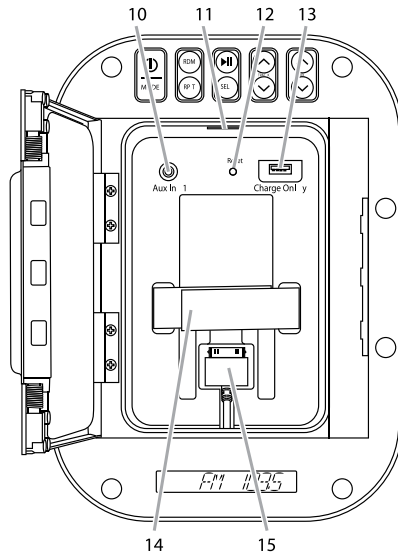
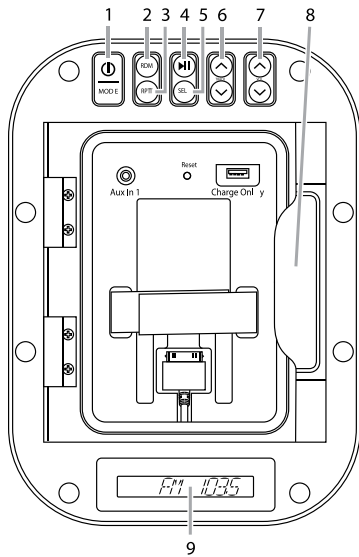

11. Interior Light: When the unit is turned on the LEDs will automatically illuminate the interior compartment.

12. Reset/Pair Button (Reset): Press to reset the microprocessor or pair a wireless remote.

13. USB Charging Socket: To charge a device plug the cable into the USB socket then into the device. **Note:** The unit will not control the device. The cable will not transfer audio into the entertainment center.

14. Mounting Straps: Holds your device securely inside the unit.

15. 30-pin Connector for Apple Products: Plug the 30-pin connector in an IPOD, iTOUCH or IPHONE. Use the track button to select the desired song.

REMOTE CONTROL BUTTON LOCATIONS AND FUNCTIONS (OPTIONAL)

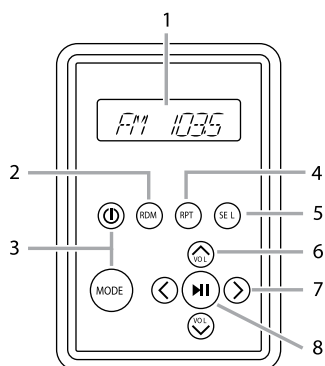

Wireless Remote Controller

- 1. Display Area:** This area displays mode information, in the radio mode the radio frequency is displayed.
- 2. Random Button (RDM):** Press the button for random controls in IPOD and Bluetooth mode.
- 3. Power and Mode Buttons:**

Wireless Remote Controller's Power Button: Press to turn on the entertainment center on. Press again to turn the unit off.

Mode Button: Press to select between input sources:

 - Radio:** FM tuner.
 - iPOD:** 30-pin connector. (Can be selected only when a device is connected).
 - Aux in 1:** 3.5mm jack.
 - Bluetooth:** Wireless connectivity.
- 4. Repeat Button (RPT):** Press the button for repeat controls in IPOD and Bluetooth mode.
- 5. Select Button:** Press to toggle between: bass, treble, balance, fader, equalizer, area, loudness and local/distance settings.
- 6. Volume:** Press to increase or decrease the volume level.
- 7. Track Buttons:**

Radio Mode: Press for automatic seek up or down for radio stations. Press and hold to activate manual tuning.

iPOD or Bluetooth Mode: Press to select the next or previous tracks.
- 8. Play/Pause Button (▶||):**

Radio or Auxiliary Modes: Press to mute the audio. Press again to restore audio.

iPOD or Bluetooth Mode: Press to pause play back. Press again to resume play.

Note 1: The wireless remote controller's display will disappear after approximately 30 seconds of no button activity to conserve its battery. Press any button on the remote controller and the LCD display will be restored.

Note 2: When the main unit is turned off, the wireless remote controller's display will disappear to conserve its battery. Press any button on the remote controller to restore the remote's display. Then press the  button to turn on the entertainment center.

BLUETOOTH OPERATION

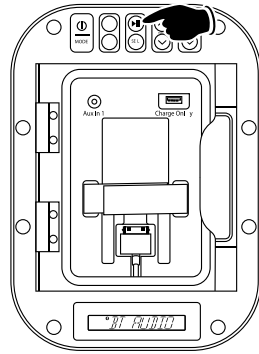
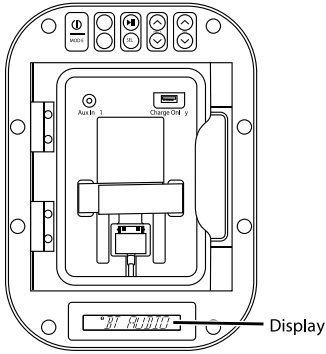

Pairing Bluetooth Devices:

1. Open the Bluetooth setup program on the mobile device and activate the Bluetooth feature.
2. Press the  button to turn on the entertainment center.
3. From your mobile device scan for available devices. Select "AQUAVIBE" to connect to the unit.
4. When the mobile device has been paired "BT" will appear in the entertainment center's display.
5. Press the **MODE** button until "BT AUDIO" appears in the display. Bluetooth audio from your mobile device can now be played through the entertainment center.

Note 1: A previously paired Bluetooth mobile device will automatically connect to the entertainment center when "BT AUDIO" is selected using the **MODE** button (if it is within range).



Note 2: If the Bluetooth mobile device is already paired with the entertainment center, select "AQUAVIBE" on your phone and touch "Connect".

Bluetooth Operation:

Note: Devices with AVRCP 1.3 or above will display text, all other device will simply show "BT AUDIO"

Play/Pause Button: Press the  button to pause the Bluetooth playback. Press again to resume playback. **Note:** The Entertainment Center display will not show the playback is pause. The mobile device will show that the playback is paused.

Changing the Track:

Press the  **TRACK** button to select a higher track. Press the  **TRACK** button to select a lower track.

Sound Controls: Use the sound controls on the main unit to adjust the volume and sound quality. **Note:** For optimum sound quality make sure the media volume on the device is set at 75% or greater.

Random Controls: Press the **RDM** button for random controls. Selecting "RDM ON" will randomly play tracks. Selecting "RDM OFF" will cancel random play.

Repeat Controls: Press the **RPT** button for repeat controls. Selecting "RPT ONE" will repeatedly play a track. Selecting "RPT ALL" will repeatedly play all the tracks. Selecting "RPT OFF" will cancel repeat play

Note: During Bluetooth audio streaming the multimedia device (IPHONE/smart phone) can be placed in the dock and charged by the USB socket.

RADIO OPERATION

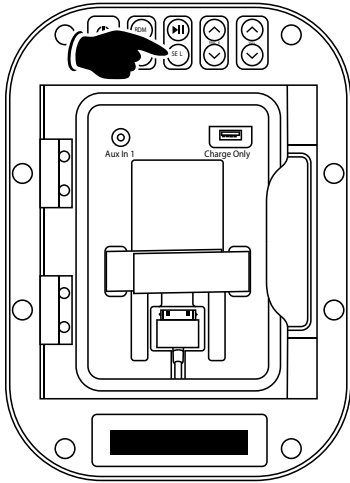

Switching from US to Europe Radio Tuning

Note: Do not change if using in North America.

1. Press the **SEL** button until "AREA USA" appears in the display.
2. Press the **VOL**  button and "AREA EUR" will appear in the display.

Note: The unit will leave feature programming after 5 seconds of no button activity.

PROGRAMMING A WIRELESS REMOTE CONTROLLER

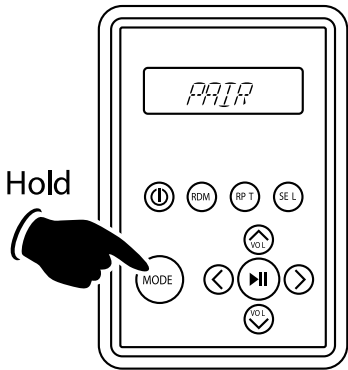

1. To pair the wireless remote with the dock push and hold the **MODE** button on the remote controller until "PAIR" appears in its display
2. While still holding the **MODE** button on the wireless remote controller, press the **RESET** button in the interior of the waterproof compartment to pair the devices.
3. If the pairing is successful, the dock will restart and "PAIR" will disappear from the remote's display. Release the **MODE** button on the remote controller.

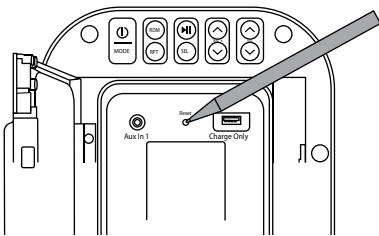

SWIM SPA TROUBLE SHOOTING GUIDE

NOTHING ON THE SWIM SPA OPERATES-

1. Check the control panel display for any messages. If there is a message, refer to the diagnostic section on that model swim spa. There you will find the meaning of the message and what action is to be taken.
2. If there is no message on the control panel, check and reset the GFCI breaker. This is located on the front of the swim spa in the lower left hand corner, behind the double plastic doors.



**The swim spa GFCI breaker or disconnect should be located in a weather proof box close to the swim spa, but no closer then 5 feet.*

If the swim spa does not respond, contact your local service company.

PUMP(S) DO NOT OPERATE -

1. Press the "Jets" button on your control panel.
If you hear the pumps trying to operate:
 - A. Check that all the slice valves are open. See photo on page 14.
 - B. Pump may need to be primed. See page 20.
 - C. Check that the air controls are open. See photo on page 11.*If you do not hear anything from the pump, contact your local service company.*

POOR JET PERFORMANCE

1. Make sure pump is operating
2. Check that the water level is adequate (up to minimum safe water level side)
3. Make sure the jets are open and the air controls are open. See page 11.
4. Check for dirty filters. Clean if necessary.

SWIM SPA TROUBLE SHOOTING GUIDE

SWIM SPA NOT HEATING

* If the swim spas heater has failed, the majority of the time it will trip the GFCI breaker. If the swim spa is not heating and has not tripped the breaker, please follow these steps:

1. Check the control panel for diagnostic messages. Refer to your swim spa models diagnostic message area in previous sections. Follow steps to alleviate message.
2. Check water set temperature at control panel.
3. Check for dirty filters. Clean if necessary.
4. Check the "heat mode" that the swim spa is set in. The swim spa should be set in the standard mode or ready mode depending on the model.
5. Check the control panel for light indicator. Wait a reasonable amount of time (approximately 1 hour) to see if the water temperature is rising.
6. Check to make sure that the pump is primed and all slice valves are open.
7. Reset power to the swim spa at GFCI breaker.
8. If swim spa is still not heating, contact your dealer for service.

GFCI IS TRIPPING

A ground fault circuit interrupter (GFCI) is required by the National Electrical Code for your protection. The tripping of the GFCI may be caused by a component on the swim spa or by an electrical problem. Electrical problems include but are not limited to, a faulty GFCI breaker, swim spa component, power fluctuations, or improper wiring. It may be necessary to contact an electrician if your dealer recommends doing so.

MAINTENANCE RECOMMENDATIONS

Note: These are maintenance procedures are the responsibility of the swim spa owner to perform. These procedures are not covered by the swim spa warranty.

CLEANING JETS

The majority of jets in your swim spa can individually be turned on/off. If any of these jets become hard to turn, it will be necessary to remove the jet to clean it as grit/sand and mineral deposit may be present.

The jets in your swim spa can be removed for cleaning by unscrewing them (counter clockwise) and then pulling out the jet.



To Clean Jets

Place the jet(s) in a container, fully immerse in white vinegar. Let the jet(s) soak overnight and then rinse with water. It may be necessary to clean grit and deposits from the white jet body (mounted in the swim spa shell) by using a small bristled brush.

CLEANING DIVERTER VALVES

Mineral deposits, grit and sand may get into the internal parts of the diverter valves over time. The diverter valves may become difficult to turn or not turn at all.

Remove the handle from the top of diverter valve by gently prying up on both sides of the handle assembly at the same time.

Turn the cap piece counter clockwise. It may be necessary to put a clean towel over the cap and turn it with a wrench.

Once loose, the cap and handle can be pulled up out of the white plumbing fitting.

Wipe down the internal piece that attaches to the cap and handle.

Soak the cap and handle in white vinegar.

The white plumbing fitting should also be wiped down. If the surface of the white plumbing has become too abrasive, you can take wet, fine sandpaper and smooth it out. It is also helpful to use a lubricant (use silicone based, not petroleum based) to allow for an easier turn of the diverter handle.

Rinse the diverter internals and reassemble.

In the future, it is helpful to turn the diverter valve only when the pump is not on. Cleaning your diverter valve should occur every time you drain your swim spa.

DRAINING YOUR SWIM SPA

Due to the physical size of the swim spa, we recommend draining your swim spa with a submersible sump pump. Draining your swim spa with a conventional swim spa drain is not a reasonable option. When draining the Momentum 80 swim spa always drain the water from the swim spa side before draining the swim side.

MAINTENANCE RECOMMENDATIONS

CARE OF YOUR SWIM SPA COVER

Always cover your swim spa when not in use. This will greatly reduce energy consumption and will cause swim spa water to heat more rapidly. Water loss and chemical usage will also be reduced.

- Be sure to lock down all straps on cover after each use to prevent wind damage.
- Do not allow swim spa to sit uncovered in direct sunlight. This may cause damage to exposed surfaces of swim spa and possible discoloration of swim spa fittings.
- Periodically hose off both sides of swim spa cover for maximum life of cover. Once a month use a vinyl cleaner and conditioner on the vinyl portion of your cover. Rinse residue off.
- Keep cover open for 15 min. after adding chemicals to prevent off gas damage.

NOTE: IF YOUR SWIM SPA IS GOING TO BE LEFT EMPTY FOR PROLONGED PERIODS, DO NOT REPLACE COVER DIRECTLY ON SURFACE OF SWIM SPA. PLACE 2"-3" BLOCKS BETWEEN COVER AND SWIM SPA. THIS ALLOWS FOR ADEQUATE VENTILATION OF COVER AND SWIM SPA.

CARE OF YOUR SWIM SPA CABINET

The swim spa cabinet is made from a UV resistant Polymer material. The cabinet requires only periodic cleaning with a stream of water from a garden hose.

FILTER CLEANING

NOTE: Never operate the swim spa without the filters installed. Damage to the pumps and other components could result from operation without filters installed.

1. Turn power off to the swim spa.
 2. Remove any large or floating debris from the filter area.
 3. Allow the weir door to fall back towards the filters in order to remove the filter housing.
 4. Lift up on the plastic housing and the entire housing will pop out.
- *NOTE:** When lifting the housing, be careful not to lift too far, as you could break the floating weir door. Damage to weir door is not warranted.
5. Pull the plastic skimmer plate out from the filter basket in order to gain access to the filters.
 6. Unscrew the two filter cartridges located inside the filter basket and remove for cleaning.
 7. Both filters should be rinsed off and the non-Eco-Pur filter (blue filter) should be soaked in a cartridge cleaner. Follow applicable cartridge cleaner instructions.
 8. Re-install filters and replace weir housing.



NOTE: Do not soak the Eco-Pur filter (darker filter) in a filter cartridge cleaner. Rinse off only.

NOTE: Eco-Pur filters should be replaced every 6 months. Non Eco-Pur filters should be replaced every 12 months.

MAINTENANCE RECOMMENDATIONS

CARE OF LAMINAR FLOW JETS:

- In order to keep your Laminar Flow Jets operating properly, follow these instructions in sequence:
 - Turn off Laminar Flow Jets
 - Remove outer ring by turning face counter clockwise
 - Remove internal Jet insert with a pair of needle nose pliers
 - Clean plastic filter at the back of the Jet insert so all holes are free of debris
 - Reinstall Jet insert and outer ring



NOTE: To prevent premature failure of your swim spa cover, always turn Laminar Flow Jets down so that they do not hit the cover when the cover is closed. You do not want to completely turn jets off. Doing so may cause a build up of stagnant water in the water line if not used often.

MAINTENANCE RECOMMENDATIONS

STAINLESS STEEL

Master Spas uses stainless steel in a number of our swim spas. Its lasting beauty and resistance to corrosion make it an excellent material for handrails and jets faces.

With the proper care it will keep its luster for many years. All stainless steel can corrode given the right circumstances so we have provided a guide to help you keep the stainless components in your swim spa looking nice.

Stainless steel derives its ability to resist corrosion by forming a very thin transparent coating on the surface when exposed to oxygen. This coating can be damaged by abrasive materials such as steel wool, sand paper, and other cleaning materials that are abrasive. Chlorine salts, sulfides, or other rusting metals can also erode this thin coating exposing the metal to corrosion.

The best defense to combat corrosion on stainless steel components in your swim spa is make sure that it is kept clean and free of any chemical build up.

Always:

- Clean frequently with clear clean water.
- Remove any rust spots as soon as they appear with vinegar or a brass, silver, or chrome cleaner.
- Use a good car cleaning wax for extra protection.

Never:

- Clean with mineral acids or bleaches.
- Clean with steel wool or any other abrasive material.
- Leave in contact with iron, steel any other metals.

NOTE: Failure to take proper care of the stainless steel fixture could result with them rusting. Rusting is not covered by the warranty.

NOTE: Do not cover the swim spa for 15 minutes after adding chemicals as the off gas can cause unwarranted damage.

SWIM SPA PROPULSION SYSTEM TECHNICAL INFORMATION

Critical replacement component part numbers:

WARNING: Items listed below shall only be replaced with identical components unless approved by Master Spas Engineering Department. Any change or alteration to the system components will cause a safety hazard and void the safety certification.

- Propulsion suction grate assembly: X804490

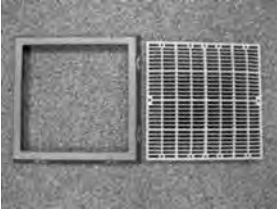

- Propulsion grate fasteners (4 per grate): X717900



- Propeller
 - Wave.....X400125
 - Wave XPX400820
 - Wave XP PROX400820
- Max. Frequency
 - Wave.....66Hz.
 - Wave XP60Hz.
 - Wave XP PRO68Hz.

PROPULSION SUCTION GRATES MISC. SPECIFICATIONS:

- Wall mount only
- Life span 7 years
- Tools required – No. 2 Phillips screwdriver
- Pulley system shall be 1:1 ratio only

Note: *Fittings and fasteners should be observed for damage or tampering before each use of the swim spa.*

WI-FI CONTROL CONNECTION

Your Swim Spa is equipped with a Wi-Fi module that allows you to connect to the router in your home. Once the system is connected you will be able to operate the spa and swim functions VIA your I Phone or I pad. You will need to visit the app. store and down load the Balboa Water group Wi-Fi spa control app to make this connection.

SWIM SPA CARE AND MAINTENANCE RECORD

DATE DATE DATE DATE DATE DATE DATE DATE

Drain & Clean Swim Spa								
Clean Filter Cartridge								
Soak Filter Cartridge in Solution								
Test GFCI								
Clean and Condition Swim Spa Cover								
Miscellaneous Service								
Miscellaneous Service								

SWIM SPA CARE AND MAINTENANCE RECORD

DATE DATE DATE DATE DATE DATE DATE DATE

Drain & Clean Swim Spa								
Clean Filter Cartridge								
Soak Filter Cartridge in Solution								
Test GFCI								
Clean and Condition Swim Spa Cover								
Miscellaneous Service								
Miscellaneous Service								

SWIM SPA CARE AND MAINTENANCE RECORD

DATE DATE DATE DATE DATE DATE DATE DATE

Drain & Clean Swim Spa								
Clean Filter Cartridge								
Soak Filter Cartridge in Solution								
Test GFCI								
Clean and Condition Swim Spa Cover								
Miscellaneous Service								
Miscellaneous Service								



MASTER SPAS[®]

6927 Lincoln Parkway
Fort Wayne, Indiana 46804
800-860-7727
www.masterspas.com

POP14MPOM
201707